

# **ETM-1**

## **3-AXIS HALL MAGNETOMETER**

---

### **User's Manual**

**Version W&G**

**(Revision 1.2)**

**June 1998**

---

110 ch. du Pont-du-Centenaire, CH-1228 GENEVA (SWITZERLAND)

TEL. +41 (22) 884 33 11

FAX. +41 (22) 884 33 10

e-mail : [contact@metrolab.ch](mailto:contact@metrolab.ch)

**INDEX**

Conventions.....	2
1. GENERAL DESCRIPTION.....	3
2. SPECIFICATIONS .....	5
3. SAFETY .....	6
4. PRINCIPLE OF OPERATIONS.....	7
4.1. Operating procedure.....	7
4.2. ON/OFF .....	7
4.3. RANGE .....	8
4.4. Bz (B on Z axis) .....	8
4.5. HOLD.....	9
4.6. ZERO.....	9
5. INTERFACE RS 232c COMMANDS .....	11
5.1. INTRODUCTION.....	11
5.2. ENQ (ENQUIRE displayed value) .....	11
5.3. RNG (RaNGe).....	12
5.4. HLD (HoLD) .....	12
5.5. MAP .....	12
5.6. STZ (Set To Zero).....	13
5.7. BZA (B on single Axis) .....	13
5.8. VER (firmware VERsion) .....	13
5.9. ST1 (STatus register 1).....	13
5.10. ST2 (STatus register 2).....	15
5.11. OFF (auto OFF) .....	16
5.12. BAT (BATtery Level).....	16
5.13. RST (ReSeT).....	16
5.14. LLO (Local LockOut).....	16
5.15. ERR (ERRor) .....	16
5.16. CLE (CLear Error).....	17
6. APPENDIX A: ETM-1's display .....	18
7. APPENDIX B: WARRANTY,  notice.....	20
8. APPENDIX C: Summary of the RS 232c commands.....	22

## Conventions

This manual uses the following conventions:

<HOLD> : name of a keyboard button.

[ENQ] : a RS 232c command.

"BAT" : an indication in the display.

'1' : a parameter or option.

200 : a string of characters returned by the ETM-1.

## 1. GENERAL DESCRIPTION

---

The METROLAB 3-axis Hall Teslameter "ETM-1" is an instrument using HALL elements to measure magnetic fields. The main feature of the ETM-1 is the simultaneous measurement of the 3 axis, X, Y, Z, which are set at 90° angle, allowing a direct measurement of the magnetic field intensity, **without a particular orientation of the sensor (isotropic)**.

The ETM-1 calculates and displays the modulus of the magnetic field as per the equation :

$$B = \sqrt{B_x^2 + B_y^2 + B_z^2}$$

The magnetic field value is displayed in (mT) on a 3½ digits Liquid Crystal Display.

The ETM-1 and its probe provide a portable magnetic field measuring system. The keyboard gives the operator complete control over the different measurement modes as well as over the zeroing of the probe.

All the functions of the ETM-1 (controls and measurements) can be accessible to a computer (supplied by the user) via a RS 232c serial interface.



**Figure 1 : The ETM-1**

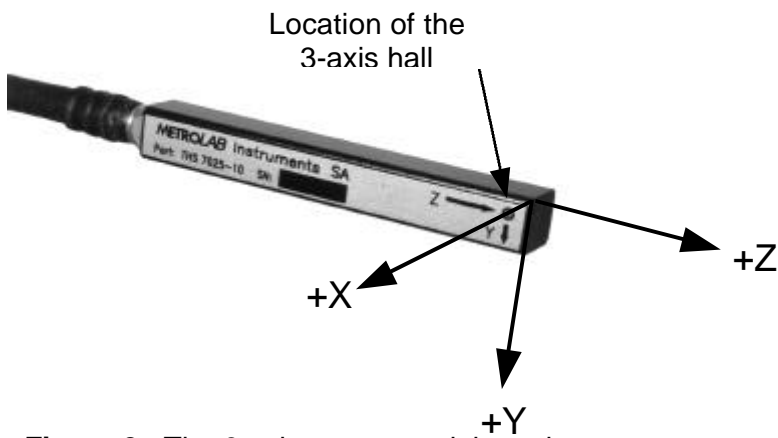

**Figure 2 : The 3 axis sensor and the axis direction**

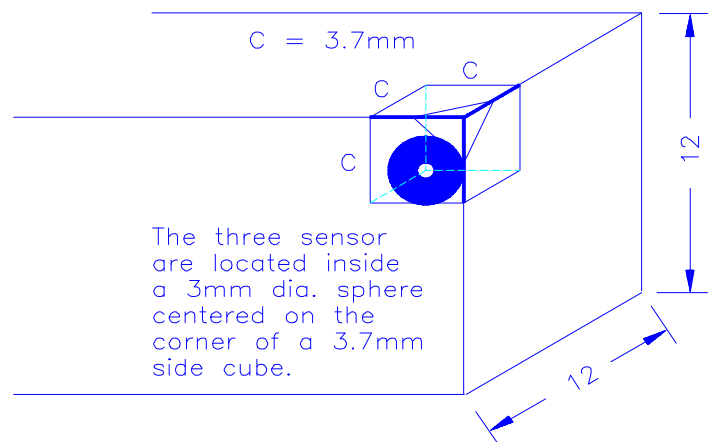

**Figure 3 : Hall sensor position**

## 2. SPECIFICATIONS

---

Ranges:	19.99 mT, 199.9 mT, 1999 mT "DC" full scale ranges. Automatic or manual ranging.
Resolution:	0.01 mT, 0.1mT, 1mT.
Accuracy:	±2 % of reading or ±3 digits.
Temperature coefficient of the gain:	±0.05% / °C (from 25°C).
Display:	3 ½ Digits LCD, mTesla units.
Update rate:	0.4 sec or hold.
Measurement mode:	3-axis or one axis, i.e. Bz ( or Bx, By).
Operating - temperature:	0°C to +40°C.
- magnetic field:	Main unit only: 0.1T (1.5T when battery is removed).
Storage temperature:	-20°C to +60°C.
Size - main unit:	160 x 80 x 30 mm.
- sensor:	12 x 12 x 100 mm.
Weight:	250 g.
Interface:	RS 232c.
Battery:	9 Volt, type SLM9V, Lithium, 22h duration (display reads "BAT" when battery is low). If connected with RS 232c to computer, duration of battery is much less.

A ETM-1 system is supplied in its own hard-side plastic carry case, with one piece of each following item:

- Hand held instrument.
- 3-axis sensor (model THS7025-10) with its 1.5 meters shielded cable.
- 9 Volt Lithium battery.
- 110V or 220V plug-in power supply (model HPS7025-10).
- Zero field chamber (model ZFC7025-16).
- 3 meters serial interface cable with Sub-D 9 poles IBM-PC type connector (model SC7025-13).
- User's manual.

### 3. SAFETY

---

The ETM-1 can measure magnetic field up to 2 Tesla.

We strongly **WARN and URGE** the user to take into consideration the **effects** of such strong magnetic fields.

The ETM-1 unit is powered by a 9 Volt battery which is partly made out of iron. Meaning that strong mechanical forces are applied to the battery and therefore to the ETM-1 unit.

**The main unit, WITH THE BATTERY INSIDE, should not be exposed to magnetic field stronger than 0.1 Tesla.**

By neglecting this warning, the ETM-1 might be pulled away from the hands' user.

**EVEN WHEN BATTERY IS REMOVED, the main unit should not be exposed to magnetic fields stronger than 1.5 Tesla.**

The operation and the accuracy of the ETM-1 cannot be guaranteed as long as it remains in the magnetic field. Without excluding that permanent damage can occur to the instrument.

When battery is removed and the plug-in power supply is being used, be aware of the similar danger, since the transformer of the power supply contains a mass of iron. Therefore the plug-in power supply should never be exposed to magnetic field stronger than 0.1 Tesla.

**METROLAB Instrument SA cannot be hold responsible for any accident occurred by the misuse of the ETM-1 or by none-respect of the present warning.**

## 4. PRINCIPLE OF OPERATIONS

### 4.1. Operating procedure

- Slide the battery door at the back of the unit. Install the 9V battery and replace the battery door.
- Plug the sensor into the connector at the top of the unit.
- Turn on the ETM-1 by pressing the ON/OFF switch for at least 1 sec.

The ETM-1 is being manually operated by 5 switches.

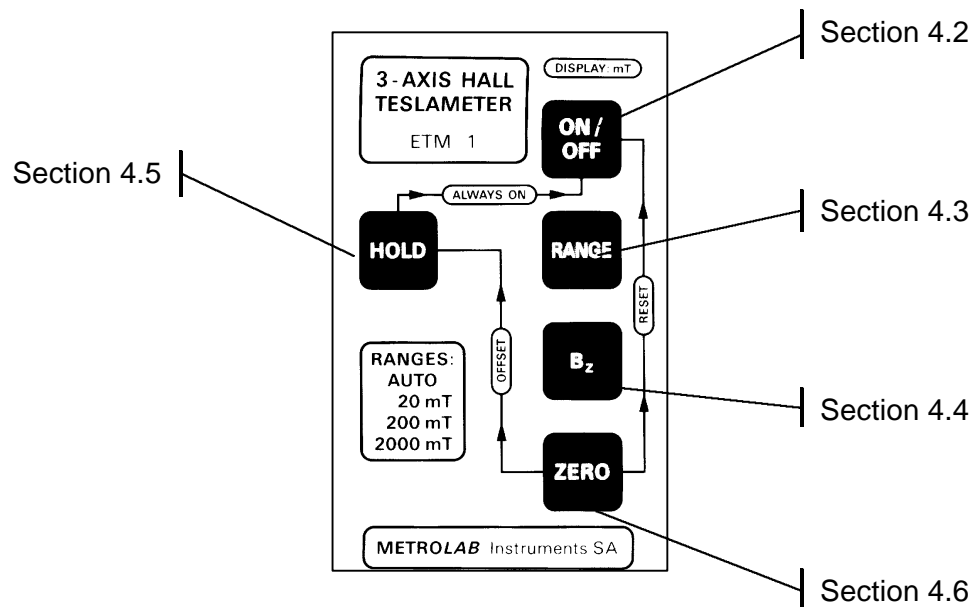

Figure 4 : keyboard view

### 4.2. ON/OFF

On and Off switch.

*Press once for at least 1 sec :* instrument is On.

*Press again :* instrument is Off.

If the <ON/OFF> switch of the ETM-1 is not being used or if no RS 232c command is sent, the ETM-1 switches off automatically after ~ 3 minutes.

To disable the automatic switch Off, press the button <HOLD>, hold it and then press <ON/OFF>. The display shows "On" for about 0.4s to indicate that the instruments is now On until you turn it Off by using the <ON/OFF> button.



This function is recalled on the keyboard by ALWAYS ON

The [OFF] command can cancel or enable the automatic switch Off. (See section 5.11, page 16.)

Also, when the battery is too low, the display indicates "BAT" and a few minutes later, the ETM-1 switches Off by itself.

#### 4.3. RANGE

The values of measurement are displayed in three ranges :

1. 19.99 mT
2. 199.9 mT
3. 1999 mT.

When the ETM-1 is switched On, it is set on autoranging mode and it displays the measurement in the most appropriate range. By pressing <RANGE>, it switches from Autoranging to 1999, by second pressing to 199.9, by third pressing to 19.99 and then switches back to autoranging mode. Before displaying the value of the magnetic field, the ETM-1 displays the selected range for a **half second**. Refer to the following chart:

Pressure on <RANGE>	Range of measurement	Range indication in the display
<i>When switched On</i>	<i>Autoranging</i>	
<i>1st</i>	<i>up to 1999</i>	<b>0</b>
<i>2nd</i>	<i>up to 199.9</i>	<b>0.0</b>
<i>3rd</i>	<i>up to 19.99</i>	<b>0.00</b>
<i>4th</i>	<i>Autoranging</i>	<b>Aut.</b>
<i>...</i>		

#### 4.4. Bz (B on Z axis)

The <Bz> button toggles between 3 and single axis measurements. To distinguish between these two modes, the sign "+" or "-" is displayed with the magnetic field value in single axis mode. Otherwise no sign is displayed.

By default, the chosen axis is 'Z'. The access to another axis is possible via the RS 232c command [BZA] (see section 5.7, page 13).

*When switched On :* 3 Axis measurement  
*Press once :* measurement of a single axis (Z) (display of "+" or "-")  
*Press again :* comes back to 3 Axis measurement

#### 4.5. **HOLD**

As long as the button <HOLD> is pressed down, **the display of the measured value is held**. The sign " ▲ " comes in the display. By releasing <HOLD>, the ETM-1 continues its measurement and gives new values. This is the **normal** operation of the button.

<i>When switched On :</i>	running mode
<i>Press :</i>	displayed value is held (display of " ▲ " )
<i>Release:</i>	running mode

If user prefers to handle the button <HOLD> in the toggle way, he can do so via an RS 232c interface Command (see section 5.4, page 12). This is the **toggle** operation of the button. Button <HOLD> will be used as follows :

<i>Press :</i>	displayed value is held (display of " ▲ " )
<i>Release:</i>	displayed value is still held (display of " ▲ " )
<i>Press :</i>	go back to running mode
<i>Release</i>	still in running mode

Note: when pressing the button <HOLD>, holding it and then pressing <ON/OFF>, the automatic switch Off will be disabled (see section 4.2, page 7).

#### 4.6. **ZERO**

This button supplies **three functions** : Clearing of an error, User's Offset and System Offset.

A) While using the ETM-1 an error may occur. Display reads "Er.n", where 'n' indicates the error number (error description list is in section 5.15, page 16). The button <ZERO> clears the error and its indication.

<i>Press &lt;ZERO&gt; once :</i>	clear the error
----------------------------------	-----------------

B) The offsets of the Hall sensors are calibrated at the factory. They are called System Offset.

If the user of the ETM-1 needs to readjust the Offsets, he has to **place the probe in the zero field chamber**, then press button <ZERO>, hold it and press button <HOLD>. The Offsets is then measured and memorized. The new set of Offsets remains after switching off the ETM-1. Even if the ETM-1 is in single axis mode, the offset measurement is performed on the 3 axis.

<i>Press &lt;ZERO&gt;, hold it, press &lt;HOLD&gt; :</i>	User's Offset
--	---------------

The User's Offsets is recalled on the keyboard by OFFSET

**Warning:** because the ETM-1 is an instrument measuring 3 axis, the User's Offset **cannot** be used to offset the display when the sensor is in a given magnetic field (i.e. relative measurements) otherwise the measurements will be dependent on the sensor orientation !

C) To restore the System Offset defined at the factory, the user will press <ZERO>, hold the button and press <ON/OFF>. This action resets the default parameters, including that the Z axis will be the default axis when pressing the <Bz> button.

*Press <ZERO>, hold it, press <ON/OFF> :* System Offset

The System Offset is recalled on the keyboard by

## 5. INTERFACE RS 232c COMMANDS

---

### 5.1. INTRODUCTION

**Ensure** the instrument is Off before connecting the supplied RS 232c cable from the ETM-1 to the serial port of the computer.

Set the computer with the following RS 232c parameters :

9600 bauds, 8 bits, no parity, 1 stop bit, No XON/OFF.

The control of the ETM-1 through the serial interface is made with a set of commands. Every command consist of a string of ASCII characters using the following syntax: a root of 3 mnemonic characters then one or zero parameters, then the characters 'carriage-return' (ASCII 13) and 'Line-feed' (ASCII 10). The root and the parameter are separated by a comma.

Note: the characters 'carriage-return' - 'line-feed' are **mandatory for any command**, as well as they are returned at the end of any string of characters sent by the ETM-1. However, to clarify the text, they have been omitted in the command description.

Some commands are 'read only' (ex: [ENQ]), or 'write only' (ex: [CLE]). The others are 'read and write' commands. They are used to set a parameter or an option. In 'write' mode these commands include the parameter (ex: [RNG,2]) and in 'read' mode these commands have no parameter (ex: [RNG]) and the present parameter value is returned by the ETM-1.

The set of commands is described in the following sections.

### 5.2. ENQ (ENQUIRE displayed value)

The [ENQ] Command returns the value of the magnetic field.

The returned string of characters corresponds to the display. This command will return the field value presently displayed. If the ETM-1 is overloaded, the [ENQ] Command will return: **O.L.**

If the [ENQ] Command is sent when the ETM-1 is changing the range of measurement (display reads " - - - "), the returned string of characters will be: **!**

The [ENQ,n] Command gives the value of the magnetic field of the individual axis, where :

n = 1 for X Axis  
n = 2 for Y Axis  
n = 3 for Z Axis

Note: if the ETM-1 is in single axis mode, [ENQ] will return the magnetic field value of this axis only. Whereas [ENQ,n] will return 0 if 'n' refers to one of the none-selected axis.

### 5.3. RNG (RaNGe)

The [RNG,n] Command modifies the ranges of measurement where :

n = 1	or	20	sets 19.99 mT range
n = 2	or	200	sets 199.9 mT range
n = 3	or	2000	sets 1999. mT range
n = 0			sets in autoranging mode.

The [RNG] Command returns the current status of range in a string of characters which has the following meaning :

0	for the autoranging mode
20	for the 19.99 mT range
200	for the 199.9 mT range
2000	for the 1999. mT range.

### 5.4. HLD (HoLD)

The [HLD,n] Command holds or releases the display where :

n = 1,	display is held
n = 0,	display is running.

The [HLD] Command returns the current status of Hold mode.

The [HLD,n] Command alternates normal and toggle operation of the button, where :

n = 2,	button <HOLD> is in toggle operation
n = 3,	button <HOLD> is in normal operation.

(see section 4.5 at page 9 on how to use button <HOLD>).

Note : The selected operation, normal or toggle, is memorised. The chosen operation remains after switching off the ETM-1.

### 5.5. MAP

The [MAP,n] Command sends to RS 232c the displayed value where :

n = 1,	at each press of button <HOLD> the displayed value is sent to RS 232c
n = 0,	release MAP function.

Note : Thanks to the RS 232c interface, the mapping of a field is very convenient. The ETM-1 is positioned where a measurement of the field has to be taken. When the user is pressing the button <HOLD>, the displayed value is sent to the computer, thus allowing easy acquisition of magnetic field values.

### 5.6. **STZ (Set To Zero)**

The [STZ,n] Command deals with the sensor offsets, where:

n = 1,      measures and memorizes the User's Offset on the three axis.

This Command has the same result as by pressing down the buttons <ZERO> and <HOLD> (See section 4.6, page 9)

**WARNING** : to measure the User's Offset, the user has to place the probe in the zero field chamber which itself must be in a magnetic environment below 0.15 mT (1.5 Gauss or about ~3 time the Earth magnetic field strength).

n = 0,      reverts to System Offset.

This Command has the same result as by pressing down the buttons <ZERO> and <ON/OFF>. (See section 4.6, page 9)

The [STZ] Command returns 0 if ETM-1 is being used with System Offset or returns 1 if it is being used with User's Offset.

### 5.7. **BZA (B on single Axis)**

This command allows the user to select any of the three single axis or the 3 axis mode.

The [BZA,n] Command sets the Axis mode where :

n = 1,      for the X axis  
 n = 2,      for the Y axis  
 n = 3,      for the Z axis  
 n = 0,      for the 3 axis mode.

Note: by pressing the <Bz> button, the display indicates the magnetic field measured with the last single axis selected by the [BZA] Command.

The [BZA] Command returns the current status of the axis mode.

### 5.8. **VER (firmware VERsion)**

The [VER] Command returns the firmware version in the following string of characters.

***METROLAB SA, ETM-1, Ver X.XX***

### 5.9. **ST1 (STatus register 1)**

The [ST1] Command returns the Status Register 1

The Status Register 1 is returned in a string of 8 ASCII characters **0** or **1** followed by 'CR' 'LF'; the **first** character received is the **most** significant bit (bit 7).

The [ST1,n] Command clears the bits of the Status Register 1

Where 'n' is a decimal value from 0 to 255 which allows to write zeroes in Status Register 1: i.e. '0' clears all bits of the Status Register 1; '255' doesn't clear any bits of the Status Register 1; '9' clears all bits except the bits 3 and 0 of the Status Register 1.

Meaning of the status register 1:

7	6	5	4	3	2	1	0
Reset or power on	0	0	EEPROM R/W Error	Battery low	Overload	Command or Com. Error	Data ready

Bit 7: reset or power on

This bit is set to 1 at power on or by a reset of the instrument using the [RST] Command.

Bit 6: always 0

Bit 5: always 0

Bit 4: EEPROM Read/Write error

This bit is set to 1 to indicate that there is an error in reading or writing parameters in the non-volatile memory (EEPROM). This is a fatal error which cannot be cleared. The instrument needs to be repaired.

Bit 3: Battery low

This bit is set to 1 to indicate that the battery level is too low and thus the battery needs to be changed. The display reads "BAT".

Bit 2: Overload

This bit is set to 1 to indicate that the range is overloaded. The display reads "O.L." . The user can select a higher range, if it is possible.

Bit 1: Command or communication error

This bit is set to 1 to indicate that the syntax of a command was wrong. The last command which gave the error is returned by the [ERR] Command.

This bit is also set in case of an error in the communication with the RS 232c interface.

Bit 0: Data ready

This bit is set to 1 to indicate that a value is available for reading. The update interval is about 0.4 sec.

### 5.10. ST2 (STatus register 2)

The [ST2] Command returns the Status Register 2.

The Status Register 2 is returned in a string of 8 ASCII characters **0** or **1** followed by 'CR' 'LF'; the **first** character is the **most** significant bit (bit 7). The bit of the Status Register 2 indicate the state of the instrument at the moment of the reading. They cannot be cleared by the user.

Meaning of the status register 2:

7	6	5	4	3	2	1	0
Reserved	0 or 1	Local LockOut	User's Offset is used	Hold	Single Axis	Range (h)	Range (l)

Bit 7: Reserved

Bit 6: 0 or 1

Can be 0 or 1. Information used at the factory only (test and diagnostic purposes).

Bit 5: Local LockOut

This bit is set to 1 when the keyboard is locked.  
It is cleared to 0 when it is in operation.

Bit 4: User's Offset

This bit is set to 1 when the ETM-1 is used with the User's Offset.  
It is cleared to 0 when it is used with the System Offset.

Bit 3: Hold

This bit is set to 1 when the display is held.  
It is cleared to 0 when the display is running.

Bit 2: Single axis

This bit is set to 1 when the ETM-1 is used in single axis mode.  
It is cleared to 0 when the 3 axis mode is activated.

Bits 1 and 0: Ranges

These bit indicate the range:

Bit 1	Bit 0	RANGE
0	0	not available *
0	1	20.00 mT
1	0	200.0 mT
1	1	2000. mT

\* Combination of 0 and 0 cannot occur.



### 5.11. **OFF (auto OFF)**

The [OFF,n] Command controls the automatic switch Off function:

- n = 0, mode auto-OFF is canceled. The ETM-1 is On until it is switched Off by using the button <ON/OFF> or the [OFF,2] Command. The display reads " On " for ~0.4 sec.
- n = 1, mode auto-OFF is enabled, meaning that the ETM-1 will be automatically switched Off by itself after 3 minutes when unused. The display reads " OFF " for ~0.4 sec.
- n = 2, the ETM-1 is switched Off !

### 5.12. **BAT (BATtery Level)**

The [BAT] Command returns the current battery level in 1/10 of Volts.

Example : 92 indicates 9.2 V

### 5.13. **RST (ReSeT)**

The [RST] Command resets the ETM-1.

The ETM-1 returns to the same status as when it has been switched On.

### 5.14. **LLO (Local LockOut)**

The [LLO,n] Command blocks or releases the keyboard.

It presents a safety if the user does not want to lose the parameters which he has modified, by touching accidentally the keyboard of the unit.

- n = 1, the keyboard is locked
- n = 0, the keyboard is in operation.

### 5.15. **ERR (ERRor)**

The [ERR] Command returns the first 3 digits of the last command which gave a syntax error.

The syntax error is indicated by bit 1 of status register 1.

### 5.16. CLE (Clear Error)

The [CLE] Command clears an eventual error.

i.e. : when the display reads "Er.2" or "Er.3"

Errors description:

If a fault is detected, the Display or the returned string of characters of the [ENQ] command indicates "Er.n", where :

- n = 1,        This is an error in reading or writing the parameters in the non-volatile memory (EEPROM).  
**This is a fatal error which cannot be cleared and the instrument needs to be repaired.**
- n = 2,        This error arises when there is a fault in the RS 232c communication or the reading of the keyboard.  
**This error can be cleared by either pressing button <ZERO> or by using the [CLE] Command.**
- n = 3,        This error occurs either during a User's Offset measurement, when the residual magnetic field is too high to be nulled.  
**The error 3 can be cleared by either pressing button <ZERO> or by using the [CLE] Command.**

## 6. APPENDIX A: ETM-1's display

---

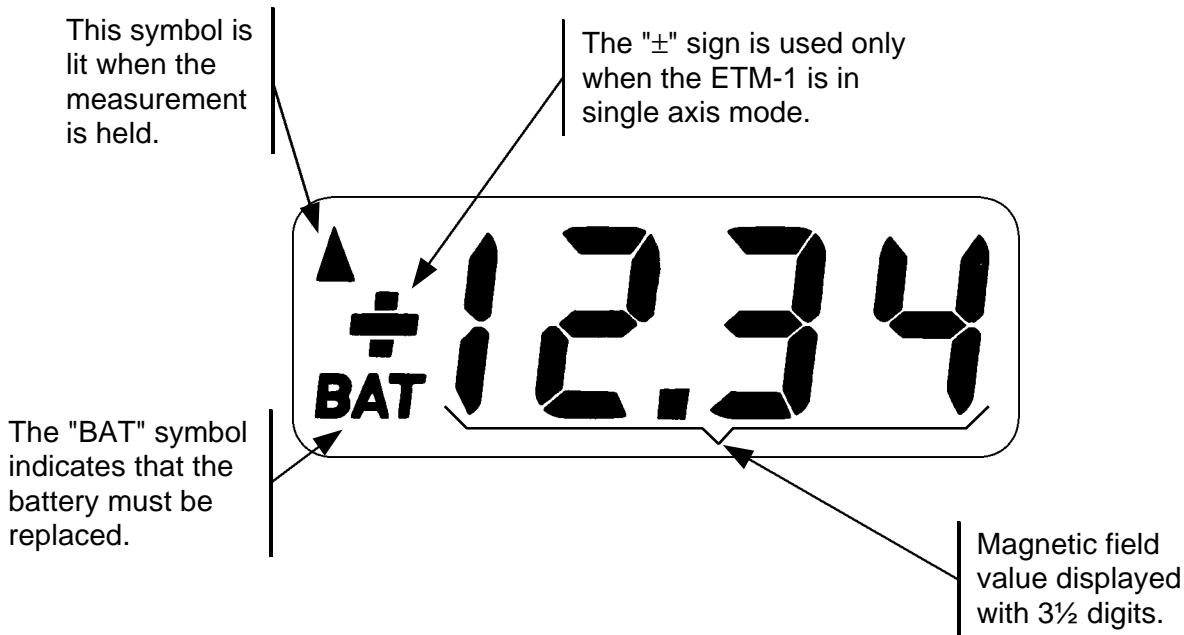







Figure 5

### Messages displayed:

#### A) Status messages (They are displayed during half second):

	This message indicates a restart of the measurement process. This happens when the ETM-1 is turned On, when it is reset or when the single/3 axis mode is changed.
	This message is displayed when the automatic Off function is disabled.
	This message is displayed when the automatic Off function is again enabled.
	Autoranging is selected.
	The range is moving to the higher range. (Taking ~0.4 sec.)



The range 1999 mT is selected.



The range 199.9 mT is selected.

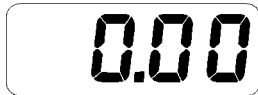

The range 19.99 mT is selected.



The ETM-1 returns to the System Offset.



The User's Offset is being measured and memorized.

**B) Error messages (They are displayed until the error condition is cleared):**

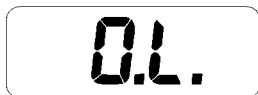

The range is overloaded, the user can select the higher range, if it is possible.

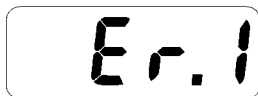

This is an error in reading or writing the parameters in the non-volatile memory (EEPROM).

**This is a fatal error which cannot be cleared and the instrument needs to be repaired.**

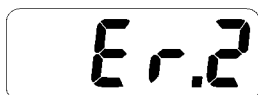

This error arises when there is a fault in the RS 232 communication or the reading of the keyboard. It can be cleared by either pressing button <ZERO> or by using the command [CLE].

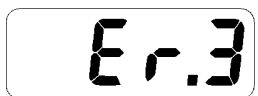

This error occurs either during a User's Offset measurement, when the residual magnetic field is too high to be nulled, or during regular measurements, when the internal memory is saturated. However, the latter should never occur in normal operation. This error can be cleared by either pressing button <ZERO> or by using the [CLE] Command.

## 7. APPENDIX B: WARRANTY

---

METROLAB Instruments SA warrants each instrument of its manufacture to be free from defects in material and workmanship. Our obligation under this warranty is limited to servicing or adjusting free of charge any ETM-1 system returned to our factory for that purpose. This warranty covers the ETM-1 and its accessories which, within one year after delivery to the original purchaser, shall be returned with transportation charges prepaid by the original purchaser, and which upon examination shall disclose to our satisfaction to be defective. If it is determined that the defect has been caused by misuse or abnormal conditions of operation, repairs will be billed at cost after submitting an estimate to the purchaser. Repair, Calibration and spare part logistics is done by:

**METROLAB INSTRUMENTS SA**  
**110 Ch. Du Pont-du-Centenaire**  
**CH 1228 Genève, Switzerland.**

**Tel: +41 22 884 33 11    FAX: +41 22 884 33 10    e-mail: [contact@metrolab.ch](mailto:contact@metrolab.ch)**

METROLAB Instruments SA reserves the right to make changes in design at any time without incurring any obligations to install same changes on units previously purchased.

This warranty is expressly in lieu of all other obligations or liabilities on the part of METROLAB Instruments SA, and METROLAB Instruments SA neither assumes nor authorizes any other person to assume for them any other liability in connection with the sales of the ETM-1.

### DAMAGE IN SHIPMENT:

The instrument should be examined and tested as soon as it is received. If it does not operate properly, or is damaged in any way, immediately file a claim with the carrier. The claim agent will provide report forms. A copy of the completed form should be forwarded to us. We will then make necessary arrangements for repair or replacement.

### CE notice

Marking by the symbol  indicates compliance of this Metrolab Hall Magnetometer to the EMC (Electromagnetic Compatibility) directive of the European Community. Such marking is indicative that this magnetometer meets or exceeds the following technical standards:

#### Testname

- Emission conducted:
- Emission radiated:
- Harmonics
- Electrostatic discharge
- RF electromagnetic field AM
- RF electromagnetic field PM
- Fast transients (Burst):
- Slow transients (Surge)
- RF common mode
- Voltage dips & interruptions

#### Standard:

CISPR11, CISPR22, EN55011(B), EN55022  
CISPR11, CISPR22, EN55011(B), EN55022  
IEC555-2, EN60555-2  
IEC801-2, IEC1000-4-2, EN61000-4-2  
IEC801-3, IEC1000-4-3, ENV50140  
ENV50204, ENV50140  
IEC801-4, IEC1000-4-4, EN61000-4-4  
IEC801-5, IEC1000-4-5, EN61000-4-5  
IEC801-6, IEC1000-4-6, ENV50141  
IEC1000-4-11, EN61000-4-11

- Power frequency field IEC1000-4-8

## 8. APPENDIX C: Summary of the RS 232c commands

Command	Description	Min/Max	Read/Write	Pages
ENQ	Measured value in mT	---	R	11
ENQ,n	Measured value in mT on a single axis	1/3	R	11
RNG	Select the measurement range	0/3;20-200-2000	R/W	12
BZA	Select the single / 3 axis mode	0/3	R/W	13
HLD	Hold the measurement	0/1	R/W	12
STZ	Set to zero (User's Offset; System Offset)	0/1	R/W	13
OFF	Disable / Enable the auto-Off	0/2	R/W	16
ST1	Status Register 1	0/255	R/W	13
ST2	Status Register 2	---	R	15
ERR	Returns the command which gave the last syntax error	---	R	16
VER	Returns the ETM-1 firmware version	---	R	13
RST	Reset the ETM-1	---	W	16
CLE	Clear an error condition	---	W	16
LLO	Lock / Unlock the ETM-1 keyboard	0/1	R/W	16
BAT	Returns the battery level in 1/10 Volt	---	R	16

Status Register	bit 7	6	5	4	3	2	1	0
	hex 80	40	20	10	8	4	2	1
1	Reset or power on	0	0	EEPROM R/W Error	Battery low	Overload	Command or Comm. Error	Data ready
2	Reserved	0	Local LockOut	User Offset is used	Hold	Single Axis	Range (h)	Range (l)