

**EMR-20/-30
EMR-21
EMR-200/-300
Radiation Meters**

Operating Manual

BN 2244/98.22



EMR-20/-30
EMR-21
EMR-200/-300
Radiation Meters

for isotropic measurement
of electromagnetic fields

BN 2244/20, BN 2244/30

BN 2244/45, BN 2244/46

BN 2244/21, BN 2244/31

Series P...

Software Version 3.00

Operating Manual

If you have any questions
about this product, please contact
the Sales Company for your locality.

Narda Safety Test Solutions GmbH
Sandwiesenstr. 7
72793 Pfullingen, Germany

© 2005

Author: J. von Freeden

Translator: John Nutley

Order no.: BN 2244/98.22

Edition: 14/05.05, P...

Previous edition:

13/04.05, P...

Subject to change without notice

Our normal guarantee and delivery
terms apply

Printed in Germany

Contents

1 Introduction

1.1	About the devices	1-1
1.1.1	Application	1-1
1.1.2	Common features	1-2
1.1.3	Differing features	1-3
1.2	About this operating manual	1-5

2 Safety instructions

2.1	Safety instructions for the NT-20 Charger Unit	2-5
-----	---	-----

3 Getting started

3.1	Power supply	3-1
3.2	Impact protection	3-11
3.3	Probe selection	3-12
3.3.1	Probe types	3-12
3.3.2	Probes with and without extended calibration	3-14
3.3.3	Probe correction data	3-16

4 Operation and use

4.1	Controls and displays	4-1
4.2	Fitting and removing probes	4-6
4.3	Switching on and off	4-8
4.3.1	Explanatory notes	4-10
4.4	Preparing for measurements	4-15
4.4.1	Defining the measurement and determining the method to be used	4-15
4.4.2	Setting the device	4-19
4.4.3	Checking readiness for use.	4-33
4.5	Making measurements	4-34
4.5.1	Short-term measurements	4-35
4.5.2	Long-term exposure measurements	4-36
4.5.3	Alarm function.	4-37
4.6	Automatic zeroing	4-39
4.7	Error messages.	4-40
4.8	Results memory (EMR-30/-300 only).	4-42
4.8.1	Storing individual measured values	4-43
4.8.2	Storing measurement sequences . .	4-44
4.8.3	Deleting measured values	4-46
4.8.4	Memory menu.	4-48
4.8.5	Printing measured values	4-54

4.9	Spatial averaging (EMR-30/-300 only)	4-58
4.10	Real-time clock (EMR-30/-300 only)	4-61
5	The optical interface	
6	Care and maintenance	
6.1	Saving probe correction data.	6-1
6.2	Cleaning the device	6-2
6.3	Lithium battery (EMR-30/-300)	6-2
6.4	Repair and maintenance information	6-3
7	Accessories	
7.1	Extension cable BN 2244/90.35	7-1
7.2	27 MHz Test Generator BN 2244/90.38.	7-2
8	Specifications	
8.1	Field strength measurement	8-1
8.1.1	General information	8-1

8.2	Display and warning indicators	8-1
8.3	Measurement functions.	8-2
8.4	Self-tests	8-2
8.5	Calibration.	8-3
8.6	Interfaces	8-3
8.7	Additional functions EMR-30/EMR-300.	8-3
8.8	General specifications.	8-4
8.9	Ordering information	8-5

9 Further reading

Appendix A: Instrument overview

A. 1	Front panel (example: EMR-300) . . .	A-1
A. 2	Side view.	A-2
A. 3	Rear view	A-3
A. 4	Rear view with series labels	A-4

Appendix B: Field probes

Index

1 Introduction

1.1 About the devices

1.1.1 Application

Quite often routine operation, maintenance and service work has to be done in areas where active electromagnetic fields are present, e.g. in broadcasting stations, etc. Additionally, other employees may be subjected to electromagnetic radiation. In such cases, it is essential that personnel are not exposed to dangerous levels of electromagnetic radiation.

Global efforts in recent years regarding effective protection have resulted in a number of national and international regulations and standards. These specify permissible limit values for power density as well as the electrical and magnetic field strengths for various frequency ranges and signal shapes.

In practice, this means that such fields which may occur at the place of work need to be measured using simple means but with sufficient accuracy to demonstrate that the relevant standards are met and to reassure those who work in areas exposed to electromagnetic fields that the safety procedures used are effective. Light, portable, battery-powered devices covering the appropriate frequencies and dynamic ranges are needed for this. The devices must also be easy to use and must provide results which can be directly compared with the limit values which are commonly applied.

1.1.2 Common features

The EMR-20/-21/-30/-200/-300 Radiation Monitors were specially developed for the purpose described in section 1.1.1. They are broadband devices for monitoring high-frequency radiation in the range from 3 kHz to 60 GHz. The non-directional field probe and high sensitivity also allow measurements of field strength in TEM cells and absorber rooms.

The units of measurement and the measurement types have been selected to allow easy comparison with the most commonly applied limit values. The results are expressed in units of magnetic and electrical field strength and power density. Alternatively, the display shows the power density as a percentage of the limit values specified in the applicable standard if a frequency-response weighted probe is used. At high frequencies, the power density is of particular significance. It provides a measure of the power absorbed by a person exposed to the field. This power level must be kept as low as possible at high frequencies. Effects related to the field strength are of more importance at lower frequencies. The devices can be set to display the instantaneous value, the maximum value measured or the average value (averaging period can be set as required). Instantaneous and maximum value measurements are useful for orientation, e.g. when first entering an exposed area. The six-minute average specified by many of the standards corresponds to the human thermal time-constant and is therefore relevant for longer periods of exposure to the electromagnetic field.

The devices are designed for ease of use in everyday situations. For example, all of the adjustments needed before a measurement are made automatically and are unaffected by exposure to the field. In other words, the device can be switched on and set up in the area where the measurement is to be made, rather than having to find a radiation-free zone for this purpose, as required by many other devices used for such measurements.

Operation of the devices has been kept as simple as possible. Some functions cannot be operated directly for safety reasons, and these remain in function even if you inadvertently press one of the control buttons, e.g. by accidentally knocking the device against the edge of a table.

1.1.3 Differing features

The EMR-20/-21/-30/-200/-300 differ in two regards (see Table 1-1):

- Probes that can be connected
- Additional functions

Probes that can be connected

The EMR-20/-21/-30 devices can be operated with only a single probe type. It is the type 8 E-field probe for EMR-20/-30 and the type 18 E-field probe for EMR-21, both measuring the electrical field strength E up to 3 GHz. These devices are suitable for making measurements in the far-

field of radiation sources since there, it is sufficient to measure a single field component to assess the radiation exposure.

The EMR-200/-300 instruments can be operated with a wide range of different probe types. The range of available probes is being updated constantly. More information is found in Appendix B and on the Internet at “<http://www.narda-sts.com>”.

In many cases, E-field probes are used because of their wide frequency range. The H-field probes are used for applications in which the magnetic field strength is most relevant. Both types are useful for making measurements in the near-field of radiation sources. The reason is that in the near-field, both field components must be determined separately in order to assess the radiation exposure.

The EMR-200/-300 devices automatically detect which probe is connected and adapt all probe-dependent functions.

Additional functions

The EMR-30/-300 devices are designed with several more sophisticated functions. Compared to the EMR-20/-200 version, a non-volatile memory for a maximum of 1500 measured values is also included. It is possible to store individual measured values or measurement sequences. The time interval between two successive measured values can be set between 400 ms and 90 s (“Actual” and “MAX” modes only). Using the built-in real-time clock, all stored results are given a time-stamp so that they can be fully documented in a subsequent printout. With the “Spatial

averaging“ mode provided in the device, it is very easy to measure the average field strength within a spatially extended area.

Features	EMR-20	EMR-21	EMR-30	EMR-200	EMR-300
Compatible probes					
Type 8 E-Field Probe 3 GHz	x	-	x	x	x
Type 18 E-Field Probe 3 GHz	-	x	-	x	x
Type 9 and higher	-	-	-	x	x
Memory for 1500 measured values	-	-	x	-	x
Real-time clock	-	-	x	-	x
Spatial averaging mode	-	-	x	-	x
Remote control	x	x	x	x	x

Table 1-1 Features of the EMR-20/-21/-30/-200/-300 devices

1.2 About this operating manual

In this manual, information applying to all five devices uses the reference “EMR”. For information applying to a subset of the devices, a more precise reference is always included (e.g. EMR-20/-30).

Notes:

2 Safety instructions

Before connecting up

This device left the factory in perfect condition. To ensure that this condition is maintained and that the device is safe to use, it is important that you read and carefully follow the instructions in this chapter.

Correct use of the device

The device must not be used for any purpose other than that for which it was designed. For more information on this, please refer to chapter 1, “Introduction” and chapter 8 “Specifications”.



Danger!

The accuracy and function of the device may be adversely affected by use outside the specified limits, improper handling, damage or unauthorized modifications or repairs.

Danger!



- Work in the vicinity of powerful radiation sources can in some cases entail risks to your life!
- Be informed of the laws, standards and guidelines which apply to you. You should thoroughly read the relevant literature. If any questions remain, consult with a specialist. A selection of the common norms and guidelines is listed in chapter 8.
- Be aware that persons with electronic implants (e.g. cardiac pacemakers) are subject to particular dangers in some cases.
- Observe the local safety regulations of the operator of the facility.
- Observe the operating instructions for equipment which is used to generate, conduct or consume electromagnetic energy.
- Be aware that secondary radiators (e.g. reflective objects such as a metallic fence) can cause a local amplification of the field.
- Be aware that the field strength in the near vicinity of radiators increases proportionally to the inverse cube of the distance. This means that enormous field strengths can result in the immediate vicinity of small radiation sources (e.g. leaks in waveguides, inductive ovens).

Danger!



- Do not contact parts which are dangerous to the touch even with this device. The devices in the EMR family do not include any special insulation characteristics.
- Be aware that in order to verify the exposure, it is often necessary to measure the E-field component as well as the H-field component. The devices in the EMR family measure one of the two components. In some cases, you will thus need two different devices or probes.
- The limits specified in the norms are frequency dependent. If you encounter a field with an unknown spectral composition, you should always assume that all spectral components fall into the frequency range with the most stringent limits. This point can be ignored if a frequency-response weighted probe is used.
- Field strength measuring devices can underrate pulsed signals. Significant measurement errors can arise, particularly with radar signals. The behavior when measuring pulsed signals is dependent on a number of factors and cannot be determined without further consideration. Detailed data pertaining to non-continuous signals (non-CW signals) for some probes is available on the Internet at "<http://www.narda-sts.com>".

Danger!

- All field strength measuring devices have a limited specified frequency range. Fields with spectral components outside of this frequency range are generally incorrectly evaluated and tend to be underrated. Before using field strength measuring devices, you should thus make certain that all field components to be measured lie in the specified frequency range of the measuring device.
- The safety of persons in electromagnetic fields may not be based solely upon the measurement results of our field strength measuring devices since the built-in redundancy is not sufficient to ensure that the devices are always fully functional.

2.1 Safety instructions for the NT-20 Charger Unit

AC line voltage

Before using the NT-20 Charger Unit, make sure that its operating voltage is the same as your local ac line power supply.

Safety Class

The Charger Unit is a Safety Class II device conforming to IEC 1010-1/DIN EN 61010-1.

Environment

Temperature

The Charger Unit is for indoor use only. It can be operated at temperatures between 0 and +45 °C.

Ventilation

Ensure that there is adequate air circulation when the Charger Unit is in use.

Condensation

The Charger Unit must not be used if condensation has formed on it. If condensation is unavoidable, e.g. when the charger unit is cold and is brought into a warm room, the Charger Unit must be allowed to dry out completely before it is switched on.

Notes:

3 Getting started

3.1 Power supply

The device is powered from two 1.2 V NiCd or NiMH batteries (Mignon AA size). The device is supplied complete with a set of batteries and a NT-20 Charger Unit.

A fully charged set of batteries will provide about 8 hours of operation. The batteries are pre-charged when delivered but will need to be fully charged before the device is first used.

Important: Make sure that the batteries are sufficiently charged for the intended task before using the device. If you are not sure about the current charge, then charge the batteries fully. Occasional overcharging does no harm.

Using rechargeable batteries

- Always handle the batteries with care.
- Never short-circuit the battery contacts, e.g. by touching both contacts simultaneously against a metal object, as this may cause the batteries to explode or catch fire.
- Do not drop, damage or dismantle the batteries and do not expose them to temperatures outside the permitted limits.
- Always follow the procedure for charging the batteries which is described in this operating manual.
- Do not charge the batteries continuously.

- Do not store loose batteries or the device fitted with batteries in a very warm place (e.g. in an automobile) for more than one or two days.
- Do not leave the batteries in the device for long periods when they are discharged.
- The batteries should be discharged and recharged periodically if they are to be stored for more than six months.
- Avoid completely discharging the batteries, as this may result in reverse polarity and make the batteries useless.

Battery voltage indicator

A bargraph of the battery charge state is displayed if you hold down the **ON/OFF** key when switching the instrument on. The remaining operating time can be estimated at 25%, 50%, 75% or 100% as shown in figure 3-1.

The battery voltage is also displayed during the self test whenever the instrument is switched on; see page 4-8.

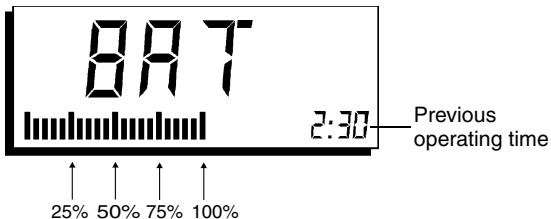

Figure 3-1 Battery voltage indicator, operating time indicator

Note: The voltage indicator is not accurate if dry batteries are being used instead of rechargeable cells.

Operating time counter (EMR-30/-300 only)

The operating time counter indicates how long the device has been operated since the batteries were last charged, so that you have an idea of how much charge is left in the batteries, assuming they were fully charged previously.

Activating the operating time indicator

Press and hold the **ON/OFF** key.

Next to the “BAT” indication, an indication of how long the device has been operated appears in the small display (hours minutes); see Figure 3-1.

Halting the operating time indicator

Release the **ON/OFF** key.

The device continues with the power-on phase, indicated by the compulsory self-test.

Resetting the operating time indicator

The operating time counter is reset automatically each time the batteries are fully charged. If the batteries are not fully charged, then the counter is not reset. In this case, the operating time indicator flashes.

If you are using dry batteries and not rechargeable cells, then it makes sense to manually reset the counter: Additionally press the **SHIFT** key during display of the operating time.

Note: If the device was not operated for a longer period of time and the charger was not connected, then be sure to take into account the automatic discharge of the batteries when estimating their remaining life (see “Trickle charging” on page 3-6).

Battery low warning

When the remaining battery charge is sufficient for about 15 minutes further operation, BAT is shown in the display alternately with the measurement result.



Figure 3-2 Low battery warning: BAT and measurement result displayed alternately

Fifteen minutes later, an audible warning signal is given and the device switches itself off.

Note: The bargraph shows the current measurement value.

Charging the batteries while in the device

The batteries can be left in the device for recharging. The EMR is fitted with a charging circuit which is powered from the NT-20 Charger Unit. Charge mode assumes that a discharged battery is to be fully recharged and the charge time is set accordingly.

- Before use, make sure that the Charger Unit operating voltage is the same as that of the local ac line supply.
- Connect the Charger Unit to the ac supply.
- Connect the Charger Unit to the charge jack of the EMR (see fold-out diagram).
- Make certain that power will be available during the entire charging interval. For instance, power might be switched off in some buildings at night.



Caution!

Do not connect the Charger Unit if the EMR is fitted with non-rechargeable batteries as this may destroy the batteries and damage the device.

- Press ON/OFF to switch on. After the self-test, the EMR automatically switches to charge mode. The display shows Chr (charge) and indicates the remaining charge time for the batteries. If the Charger Unit is connected during a measurement, the measurement stops and the device switches to charge mode automatically.

The EMR automatically switches itself off when the charge time ends (8 h for 600 mAh batteries).

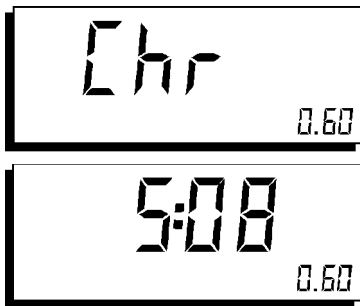

Figure 3-3 Charge mode: Chr (charge) and remaining charge time displayed alternately

Note: The small digital display in the lower right corner indicates the battery capacity in Ah assumed for the charge time calculation (0.60 = 600 mAh).

Trickle charging

The batteries are trickle-charged if the device is left switched off but is connected to an operating Charger Unit. Trickle charging is continuous and compensates for the self-discharge of the batteries.

- After charging the batteries, leave the Charger Unit connected to the device until you want to make measurements.
- If the batteries are not discharged and the device is not to be used for a few days, connect the switched-off device to an operating Charger Unit.

Important: Due to self-discharging and leakage currents in the device, the rechargeable batteries will become discharged after about a month even if you leave the EMR switched off.

Device does not switch on; batteries completely discharged

The batteries may become completely discharged through self-discharge to such an extent that the device cannot be switched on for charging. If this happens, trickle-charge the batteries for a few minutes, as described above, until the device can be switched on.

Quick-charging the batteries

A quick-charger is available as an optional accessory. You can use this device to simultaneously charge up to four batteries when they are removed from the EMR.

Replacing the batteries

If the operating life of freshly-charged batteries drops significantly below 8 hours, the batteries should be replaced.

Operation from dry batteries

Two 1.5 V dry batteries (Mignon AA size) can be used to power the device instead of rechargeable batteries. The operating life of fresh alkaline manganese batteries is about 30 hours.

If you use dry batteries, you should label your EMR to this effect so as to avoid accidental charging.

Exchanging the batteries

The batteries are exchanged as shown below:

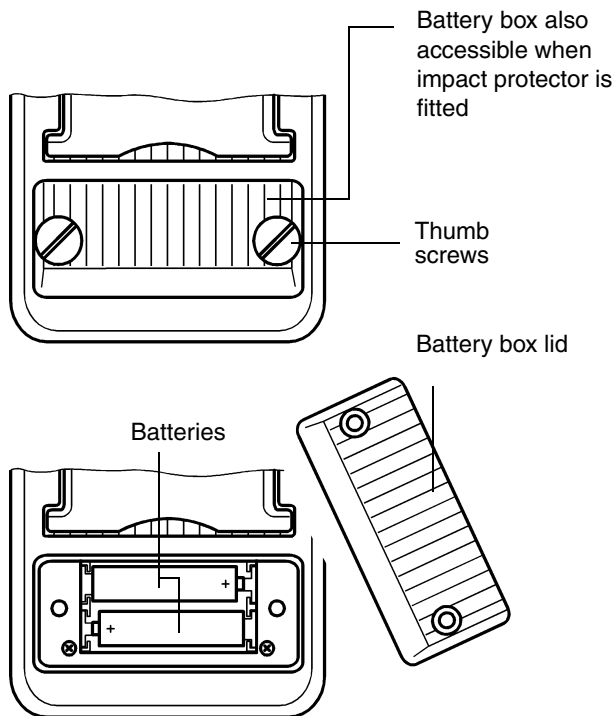

Figure 3-4 Battery box on back panel of EMR

- Undo the battery box screws and take off the battery box lid.
- Take out the old batteries and replace them with new ones. Make sure they are inserted correctly. The polarity is shown on the base of the battery box.
- Replace the battery box lid and tighten the screws. The device is now ready for use.

Protect the environment!

If the batteries are no longer required, e.g. when they are replaced or if the device is scrapped, please do not simply throw them in the trash can, as they may contain poisonous heavy metals. You will usually be able to return them for disposal to the place where you purchased them.

Notice: You can generally dispose of newer batteries which do not include a recycling symbol with your normal garbage.

3.2 Impact protection

The casing of the EMR is designed for use under rough conditions and is impact- and shock-resistant. External impact protection is provided for use under extreme conditions.

The impact protection is designed so that the front panel controls can be operated and the front panel display and back panel battery box are accessible. A tilt stand can be folded out from the back of the device. The device serial number is printed under the tilt stand.

The impact protection is fitted with a tripod bush for mounting the device on a stand for your convenience.

3.3 Probe selection

3.3.1 Probe types

The probe is plugged on to the mainframe instrument. The isotropically arranged sensors are located in the probe head. The three sensor voltages are fed via high impedance down the rod and into the mainframe instrument to avoid distorting the field.

The EMR-20/-30 instruments can only be used with a type 8 probe, the EMR-21 only with a type 18 probe (E-field probes, 3 GHz). However, the EMR-200/-300 instruments can be used with various probes. Refer to section 1.1.3 on page 1-3.

Choose your probe to fit the measurement at hand:

- In far-fields, an E-field probe is preferable due to the greater bandwidth, e.g.:
 - Type 8 and 18 for frequencies from 100 kHz to 3 GHz.
Example: Diathermy equipment, Broadcasting facilities and antennas for TV/radio/cellular radio.
 - Type 9 for frequencies from 3 MHz to 18 GHz.
Example: Microwave ovens, Broadcasting facilities and antennas for satellite communications and radar.
 - Type 11 for frequencies up to 60 GHz or if all technical application frequencies are to be covered using just one probe.

- In areas where signals of various frequencies are present simultaneously (e.g. TV, broadcast radio, mobile radio), evaluation of the power density if the individual signals are not known is only possible with probes with a weighted frequency response.
The power density as a percentage of the limit value specified in the standard is displayed instead of the measured field strength.
- H-field probes are for monitoring magnetic fields when electric fields are less important.
Example: Induction ovens, RF welding systems, erosion machines
- In the near field of broadcasting facilities and antennas, it is always necessary to measure both field components. Wherever possible, use one device with an E-field probe and another with an H-field probe. If you only have one device, make orientation measurements with an E-field and H-field probe in succession to determine which field component predominates at the work site. Then choose the appropriate probe for a long-term measurement.

3.3.2 Probes with and without extended calibration

The sensitivity of field probes to electromagnetic radiation is a function of the frequency of the field to be measured. These sensitivity variations are essentially design-dependent, but they also exhibit minor fluctuations from probe to probe.

A correction factor (relative sensitivity) is determined for each probe as part of the probe correction data. This provides compensation at an average frequency. In the standard design, these values are stored in the device.

For extreme-precision measurements, a range of probe types is also available with extended frequency response calibration. These probes are individually tested for delivery with a calibration report (or test report in the case of the type 11 probe) which records the frequency-dependent calibration factors of the probe.

Calibration factors

EMR-20/-21/-30

On the device label of the EMR-20/-21/-30 devices, there is a table showing calibration factors for selected frequencies. In devices without extended calibration, the printed values are typical. In the C-devices with extended calibration, the tables show the individually measured values for the probe delivered with the device. These values apply only to this probe.

Note: EMR-20/-21/-30 devices fitted with probes with extended calibration are called EMR-20C/-21C/-30C.

EMR-200/-300

With the EMR-200/-300 devices, the type label includes the type labels for the associated probes instead of a frequency response table; see Appendix Figure A-4. For probes with extended calibration, the frequency-dependent calibration factors can be found in the calibration report.

Note: If one particular frequency is the major component of the field, select this frequency from the table. If the exact frequency is not listed calculate the intermediate value by linear extrapolation from the table or use the value for the closest frequency to the one of interest.

If the conditions are unknown, enter a calibration factor of 1. Measurement accuracy will, however, not be maximized in this case.

3.3.3 Probe correction data

The EMR devices have an internal memory for typical probe correction data. EMR devices can store one data set for each of up to 15 different probe types simultaneously. As delivered from the factory, the EMR will have one data set stored for each probe supplied with the device. The serial number labels of the probes supplied are affixed to the type label on the back panel of the mainframe.

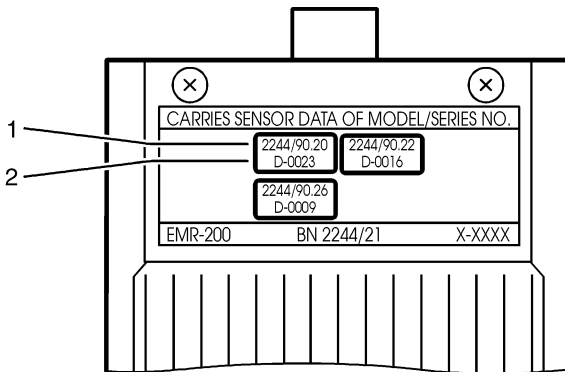

Figure 3-5 Type label of EMR-200/-300 with serial no. labels of probes supplied with the device

1 Order number of probe
2 Serial number of probe

If you are using the probes supplied, no special action is required as the mainframe detects the connected probe type and reads the relevant data set. If you plug in a probe when the device is already switched on, the following message is displayed:



Figure 3-6 EMR-200/-300 display after probe is plugged in
1 Probe type and version
2 Relative sensitivity rounded to two places

The displayed data should match the specifications on the type label of the probe.

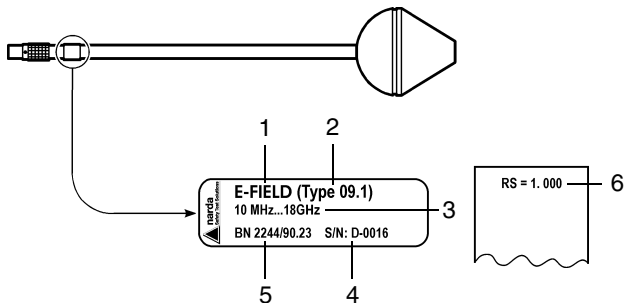

Figure 3-7 Field probe

- 1 Field type (E- or H-field probe)
- 2 Type and version number (type 9, version 1)
- 3 Frequency range
- 4 Serial number (series D, number 16)
- 5 Order number
- 6 Relative sensitivity

Using a second probe of the same type

If you have two probes of the same type and same version, you can briefly operate the device with the data set for the one probe using the second probe. This might be necessary if you need a temporary substitute probe.

Two probes of the same type and same version differ only in terms of the relative sensitivity. You can compensate for the measurement error resulting from this difference by entering an appropriate calibration factor (CAL key), or you can just ignore the error.

Normally, however, we recommend that you use a mainframe only with a single probe of a given type. In particular, do not use a substitute probe of the same type but of a different version.

If you are using another probe of the same type but which has a different version number, you should always transfer the data set for this probe to the mainframe. see “Working with probes ordered subsequently”.

Working with probes ordered subsequently

Along with the probe, you will receive a type label to be affixed and a diskette containing the data set for the probe. The procedure to be followed for saving the probe data set is detailed in section 6.1 on page 6-1.

Notes:

4 Operation and use

4.1 Controls and displays

Liquid crystal display (LCD)

Element	Function
MEM	Results memory switched on (EMR-30/-300)
AVRG MAX	Mode: No display: "Instantaneous" mode AVRG: "Average" mode MAX: "Max. instantaneous" mode AVRG+MAX: "Max. average" mode"
52.70	Large 7-segment display with measured value displayed as per selected mode and selected units.
---.---	Display range limit exceeded.
AV/m mW/cm ²	Units V/m: Electric field strength A/m: Magnetic field strength W/m ² and mW/cm ² : Power density No display: Power density as a percentage of the limit value of the applicable standard.
	Analog display of measured value (logarithmic scale) for observing trends. Keeps pace with the instantaneous measured value.
■)))	Displayed: Alarm function on No display: Alarm function off
80.00	Small 7-segment display, e.g. with limit value referred to the selected units

Table 4-1 Elements in the result display

Alarm indication

Element	Function
LEDs	Visual display of alarm state
	Audible indication of alarm state via built-in loudspeaker

Table 4-2 Alarm indicators

Keypad

Element	Function
	<p>Units selector</p> <ol style="list-style-type: none"> If units of field strength (V/m or A/m) are set: Switches to power density units, mW/cm^2. <p><i>Note:</i> If a frequency-weighting probe is used, the toggle function is disabled.</p> <ol style="list-style-type: none"> Toggles between power density units mW/cm^2 and W/m^2. <p>When LIM or CAL display is selected and the SHIFT key is pressed, this key shifts entry to the next digit in the display.</p>

Table 4-3 Keypad





Element	Function
	<p>Units selector</p> <ol style="list-style-type: none"> 1. If units of power density (mW/cm^2 or W/m^2) are set: Switches to the default field strength units for the probe 2. Toggles between field strength units V/m and A/m. <p><i>Note:</i> If a frequency-weighting probe is used, the toggle function is disabled.</p> <p>When LIM or CAL display is selected and the SHIFT key is pressed, this key increments the flashing digit by one step.</p>
	<p>Device on / off switch.</p> <p>All averaging memories are reset if you hold down the SHIFT key while pressing this key.</p>
	<p>Changes mode sequentially each time the key is pressed: "Instantaneous" -> "Max. instantaneous" -> "Average" -> "Max. average".</p> <p>When the SHIFT key is pressed, this key switches the alarm function on or off.</p>
	<p>The LIM display and input of the limit value is activated when this key is pressed once.</p> <p>When pressed a second time, this key activates the CAL display and enables entry of the calibration factor.</p> <p>The next time the key is pressed, the AT1 display and input of the averaging time is enabled. If the SHIFT key is pressed at the same time, the display shows AOFF and auto zero function is disabled.</p> <p>When LIM or CAL display is selected and the SHIFT key is pressed, this key decrements the flashing digit by one step.</p>

Table 4-3 Keypad

Element	Function
	<p>Activates the second function marked in blue on certain keys: Pressing the SHIFT key enables the \Rightarrow \uparrow, \downarrow and ALARM key functions.</p>

Table 4-3 Keypad



	<p>Determines the <i>average value of the field strength / power density</i> in a spatially extended area: A simple key press opens manual recording of the measured value. An additional key press at specific points in the area under investigation causes formation of a continuously updated root mean square value of field strength. A long key press opens automatic recording of measured values (device beeps). Continuous pressing of the key in the area under investigation causes continuous formation of the average value. <i>Deleting measured values:</i> If you hold down the SHIFT key while briefly pressing the SPATIAL key, you can delete individual memory locations in the results memory. Hold down the SHIFT key and press the key for a longer interval (CLEAR) to delete the entire results memory.</p>
	<p><i>Results memory:</i> Briefly press this key to store individual measured values. Press the key longer to open the Memory menu. This will let you examine the contents of the memory, alter the spacing interval “dt” and set the baud rate. If the SHIFT key is also pressed, this function starts or stops storage of measured sequences.</p>

Table 4-4 Keypad (EMR-30/-300 only)

	<p><i>Real-time clock:</i> Briefly press this key to display the time of day, date and year one after another. Hold down the key longer to open the menu for setting this data.</p> <p><i>Printing:</i> If the SHIFT key is pressed, stored measured values will be output to the printer which is connected.</p>
---	---

Table 4-4 Keypad (EMR-30/-300 only)

Other items



Element	Function
	<p>Optical interface For outputting measurement results and inputting calibration data.</p>
	<p>Charger jack For connecting the NT-20 Charger Unit. Connecting the Charger Unit during a measurement interrupts the measurement and the device switches to charge mode.</p>
<p>Battery box</p>	<p>Holds the rechargeable or dry batteries</p>
<p>Calibration table</p>	<p>Calibration factors for various frequencies (EMR-20/-21/-30).</p>
<p>Type label</p>	<p>Contains type labels for probes supplied with the device and for which a calibration data set is stored in the mainframe (EMR-200/-300)</p>

Table 4-5 Other items

4.2 Fitting and removing probes

Fitting a probe

The connector for the probe is a special 12-pole LEMO socket. Place the probe on the device so that the red dot on the probe plug is aligned with the red dot on the socket. Hold the locking sleeve and press towards the device until the plug locks in place.

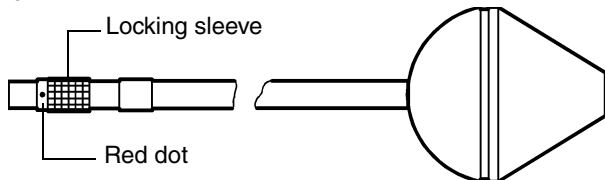

Figure 4-1 Probe connector

If you plug in a probe with the device switched on, the following message is displayed:

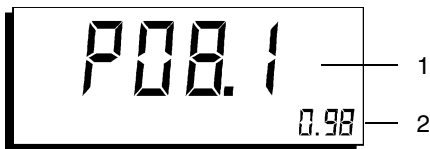

Figure 4-2 Message after probe is plugged in
1 Probe type and version
2 Relative sensitivity,
rounded to two digits

Removing the probe

Hold the locking sleeve and pull in the direction of the probe. The plug lock opens and the probe can be removed.

If you remove a probe with the device switched on, the following message is displayed:

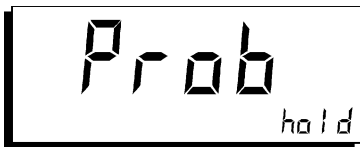

Figure 4-3 Message after probe is unplugged

The messages shown in Figure 4-2 and Figure 4-3 interrupt the measurement mode.

Do the following to continue measuring after changing the probe:

- Press any key (except ON/OFF and SHIFT).

4.3 Switching on and off

Switching on

Briefly press the **ON/OFF** key. The EMR switches on and first performs a self-test:

- The alarm LEDs light up and all display elements are visible.
- While the hardware is being checked, “CAL” and a 3 or 4 digit number are alternately displayed indicating the current calibration factor.

The self-test checks the memory, A/D converter, existing probe parameters for the current probe type and the internal operating voltages.

- The battery voltage state is represented by a four-stage bargraph display, see page 3-2.



Figure 4-4 The self-test runs immediately after switch-on

- The end of the self test is indicated by a beep.

After the self-test, a zero adjustment is performed (see section 4.6 "Automatic zeroing").

When the measurement display appears, the device is ready for use.



Figure 4-5 The device is ready for use when the measured value and other display elements are visible

To avoid the possibility of an incorrect measurement, the device always first displays the default units (e.g. V/m if an E-field probe is plugged in).

Regardless of the settings that were in force when the instrument was last switched off, the automatic zeroing function will be activated and “Instantaneous” mode selected. All other settings (LIMIT value, calibration factor CAL and ALARM on/off) will be the same as they were when the device was last switched off.

What to do if there is a fault

If the display remains blank or the device does not respond to the controls when it has been switched on, check the battery charge state. First try trickle charging the batteries (see section 3.1 "Power supply"). If this does not work, replace the batteries.

Switching off

Press the **ON/OFF** key. The EMR switches off.

4.3.1 Explanatory notes

Units of measurement

EMR-20/-30 can only be equipped with the type 8 E-field probe, EMR-21 only with the type 18 E-field probe. These devices measure the electrical components of the field. The default units are those of electrical field strength, V/m.

EMR-200/-300 measures electric field strength or magnetic field strength depending on the type of probe fitted. If flat frequency response probes are used, the default units of measurement are E in V/m and H in A/m. The device converts the measurement values to the other units of measurement, i.e. the corresponding field strength units and power density units (mW/cm^2 or W/m^2) using the standard far-field formulae for electromagnetic radiation.

If weighted frequency response probes are used, the device displays the power density as a percentage of the limit value specified in the appropriate standard.

The device automatically detects the probe type and switches to the relevant default unit when you power it up.

Important: The conversion is invalid for near-field measurements, as there is no generally valid relationship between electrical and magnetic field strength in this situation. Always use the default units of the probe when making near-field measurements.

Result modes

The analog display (bar graph) always shows the instantaneous measured value. The digital display shows the instantaneous or stored result according to one of four modes which can be selected:

- **Instantaneous**
The digital and analog displays both show the last value measured by the probe.
- **Max. instantaneous (MAX)**
The digital display shows the highest instantaneous value measured since the last reset.
- **Average (AVRG)**
The digital display indicates the current root mean square value of the field strength compiled from all the internal measurement values obtained within the averaging time since the last reset.
The averaging time can be set in specific steps.
- **Max. average (MAX AVRG)**
The digital display shows the highest average value measured since the last reset.

Reset (reset of internal measured values)

All the measured values for the above-mentioned evaluations are always simultaneously available from device-internal memories. For this reason, the results for MAX, AVRG and MAX AVRG are displayed correctly and without delay when you switch to one of these evaluation modes.

To ensure that the measurement process is always controlled, these internal memories are reset in various ways:

- Automatically when you switch the instrument on
- Manually to define the start of an observation period
To reset the display value manually, see page 4-25.
- Automatically if necessary when storing measurement values sequentially (EMR-30/EMR-300 only)
Memory sequences: see section 4.8.2 "Storing measurement sequences" on page 4-44.

The calibration factor (CAL)

The calibration factor CAL serves to calibrate the result display. The field strength value measured internally is multiplied by the value of CAL that has been entered and the resulting value is displayed or stored. The CAL setting range is from 0.20 to 50.00. Details of how to enter the CAL factor are found on page 4-28.

The CAL factor is often used as a means of entering the sensitivity of the field probe in terms of its frequency response in order to improve measurement accuracy.

Frequency-dependent probe calibration factors are provided for this application, see page 3-14. In many cases, the measurement accuracy will be sufficient even if the frequency response of the probe calibration factor is ignored. CAL can be set to 1.00 in such cases.

Note Probes having a frequency response weighted according to a specific standard have a sensitivity characteristic with a defined frequency response. The displayed value changes proportionally to the square of the value of CAL.

The limit value (LIMIT)

The limit value is used to monitor the display value automatically. It controls the alarm indication function. The limit value can be edited in the default units of the probe.

If a flat frequency response probe is used, the limit value can also be edited in the two power density units. In such cases, the limit value is converted to the new units when the units are switched.

Two independent limit values are available for the weighted frequency response and flat frequency response probes. When a change is made from one probe type to the other, the last limit value used is set automatically.

The smallest value that can be set for units of V/m is 1 V/m. See page 4-26 for information on setting the limit value.

The averaging time (ATI)

The selected averaging time is only taken into account in AVRГ and MAX AVRГ modes. The averaging time determines the period for which the root mean square will be calculated and displayed from the field strength values that occur during that period.

Note (EMR-30/-300 only): If a measurement sequence is recorded automatically in AVRГ or MAX AVRГ mode, the time interval “dt” is dependent on the selected averaging time. See section 4.8.2 “Storing measurement sequences”.

4.4 Preparing for measurements

4.4.1 Defining the measurement and determining the method to be used

Radiation source(s) and exposure

Before you set up the device, the following points should be clarified if possible, as they will help you to choose the right device settings and increase the reliability of the measurement.

- Obtain information about the radiation source. The most important factor is the frequency, as this affects the choice of limit value and is needed for selecting the correct calibration factor. Other information about the source (e.g. modulation) may be useful for determining the choice of limit value.
- How far away is the source from the point of measurement? Is the field a near-field or a far-field? Measurements made within a few wavelengths (rule of thumb is three wavelengths) of the source are near-field measurements.

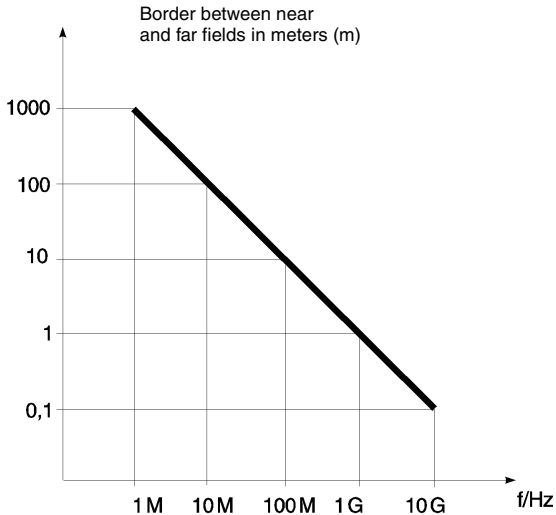

Figure 4-6 Border between near and far fields as a function of frequency (approximate values)

- Is the field a mixed field, i.e. is more than one source possibly present? If so, which of the sources is the dominant one?

How to choose the right settings

Choosing the units of measurement

The relevant standards generally contain directives indicating under which circumstances the field strength or the power density should be monitored. The main criteria for this decision are the frequency and the distance from the source (near-field or far-field conditions).

Recommendations:

It is a good idea to use the units of power density for measurements in the far-field at frequencies above about 30 MHz. The units are mW/cm^2 or W/m^2 and cover different sensitivity ranges:

$$1 \text{ mW}/\text{cm}^2 = 10 \text{ W}/\text{m}^2.$$

Probes with weighted frequency responses always deliver power density results (square of field strength) which are displayed as a percentage of the limit value specified by the relevant standard.

The default unit should be set for the following situations (section 4.3.1 on page 4-10):

- At frequencies below about 30 MHz
- In the near-field area of the source
- Where the nature of the electromagnetic field is unknown.

If more than one frequency is present in the field at the point of measurement, the frequency with the most influence should be used as the basis for deciding the measurement parameters. Otherwise, use a weighted frequency response probe.

Choosing the result mode

- "Instantaneous" and "Max. instantaneous" modes:
Both modes are suitable for short-term or orientation measurements, e.g. for determining unknown fields or as a guide when entering an area exposed to radiation.
- "Average" and "Max average" modes:
Both modes are suitable for long-term monitoring of exposure to electromagnetic radiation. They are allowed in the relevant regulations and should be used when the instantaneous measured values are subject to considerable variation.

Choosing the LIMIT value

Use the limit value suggested in the relevant standard or regulation for the selected units and result mode.

For safety's sake, select a smaller limit value (rough guide: 10% of the normal limit value) in the following situations:

- When making measurements in the near-field. The degree of exposure depends on both the electrical and the magnetic field strength, but only one of these components is measured. There is no definable relationship between the two field components.
- If the field conditions are difficult to assess, e.g. if more than one frequency is present.
- When pulsed signals are being measured.
- If not enough is known about the radiation sources, particularly if the frequency or modulation type is unknown.

4.4.2 Setting the device

Setting the units of measurement

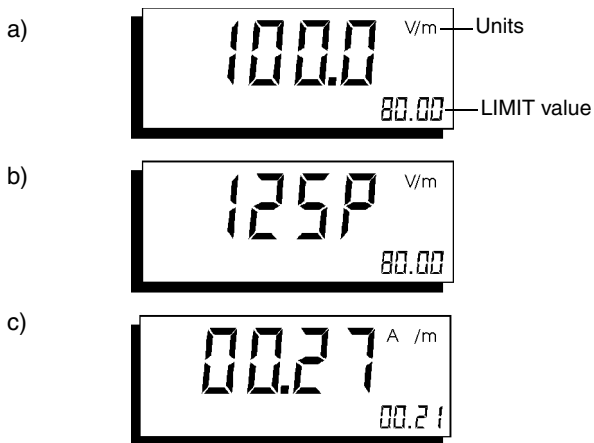

Figure 4-7 Field strength display (using flat frequency response E-field probe as example)

- a) Electric field strength (default unit)
- b) Electric field strength as a percentage of the selected LIMIT value
- c) Magnetic field strength (non-default unit)



Figure 4-8 Display (using weighted frequency response probe as example)
The display shows the power density expressed as a percentage of the limit value specified in the relevant standard.

It is not possible to select the units of measurement when a weighted frequency response probe is used.

- You can press the **V/m / A/m** key to display the measured field strength in one of three different units; compare Figure 4-7. Each keystroke switches between the following:
 - Default unit
 - Percentage of limit value
 - Non-default unit.

This would mean the following switching if you are using an E-field probe:

V/m ---> Percentage of LIMIT value ---> A/m

The underlying unit is the default unit of the probe which is plugged in.

When the device is first switched on or when you switch from power density to field strength, the default unit of the probe is always displayed.

- Using the **mW/cm²** key, you can display the computed power density in three different units:
 mW/cm² ---> Percentage of LIMIT value ---> W/m²
 For the percentage value, the underlying unit is mW/cm².

Display as a percentage of the LIMIT value

The percentage value is displayed in the format XXXP (e.g. 125P for 125 %). The underlying unit appears on the right edge of the display. The set LIMIT (see “Setting the LIMIT value” on page 4-26) appears in the lower display field. This value refers to the currently displayed unit.

When you switch over to display of the power density, the percent value changes since the power density is proportional to the square of the field strength (doubling the field strength increases the power density by a factor of four).

Unit	V/m	W/m ²
LIMIT value	50	6.6
Meas. value	100	26.5
Display	200P	400P

Table 4-6 Percentage indication in units of field strength and power density (example)

Note: The display as a percentage of the LIMIT value should not be confused with the percentage power density display that is obtained when a weighted frequency response probe is used. System constraints mean that the two displays are only comparable in certain special cases. Note that the units are shown differently in the two display modes.

The units of measurement are set using the **mW/cm²** and **V/m / A/m** keys as follows:

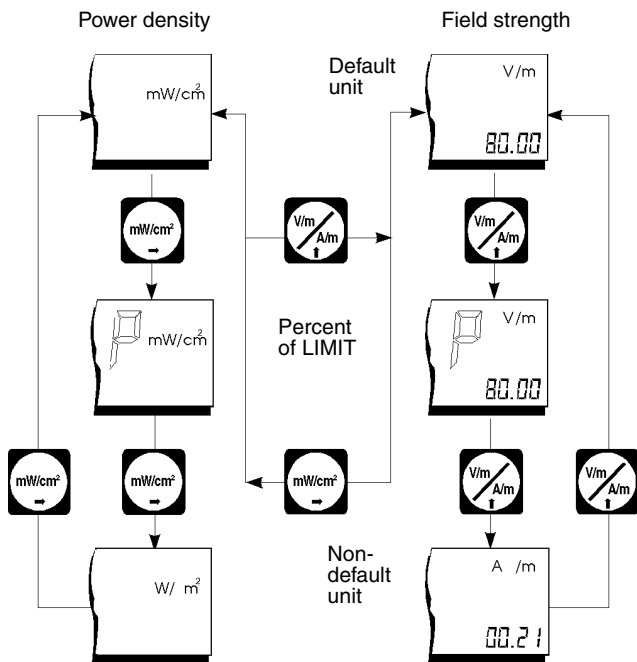

Figure 4-9 Functions of the mW/cm² and V/m / A/m keys (Example: Non-frequency weighted E-field probe)

Setting the result mode

Instantaneous result mode is automatically set when the device is switched on.

The result mode is set using the MAX/AVRG key as follows:

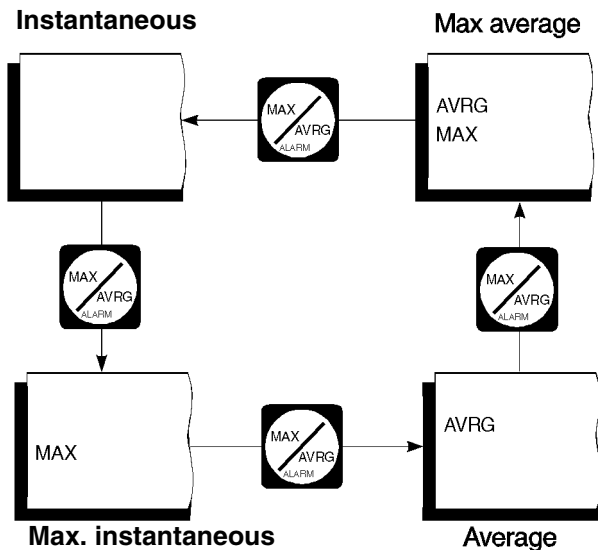

Figure 4-10 Functions of the MAX/AVRG key

Resetting the display value manually

The result display for “MAX”, “AVRG” and “MAX AVRG” modes can be reset manually if desired:

- Press the **SHIFT + RESET** (ON/OFF) keys simultaneously. The device-internal values for the above-mentioned evaluation modes will be deleted and the calculation of the measured values will be restarted.

Resetting the display values automatically (EMR-30/EMR-300 only)

In connection with the “Save Measurement Sequences” function, the device-internal values for various evaluation modes are reset automatically if necessary to ensure a controlled measurement sequence.

Note: If the time difference “dt” is 0.4 seconds, the device-internal values MAX, AVRG and MAX AVRG will be reset when you stop sequential storage.

Freezing the displayed value

You can freeze the currently displayed measured value, regardless of the result mode which is set.

- Press the SHIFT key. The frozen value is held as long as you hold down this key. When you release it, the display is updated.

Display refresh rate

In “Instantaneous” and “Max Instantaneous” modes, the display is updated continuously. It is updated every 4 seconds in “Average” and “Max Average” modes.

Setting the *LIMIT* value

First of all, check that the display shows the correct units of measurement, and set the correct units if this is not the case.

To enter the LIMIT value, do the following:

- Press the LIMIT/CAL key. The display shows the message LIM indicating that entry of the limit value is enabled.



Figure 4-11 LIM indicator. The digit which can be altered flashes in the display.

- Change the value of the flashing digit in the limit value display by pressing and holding down the SHIFT key and using the \uparrow key to increase the value or the \downarrow key to decrease the value.
If the arrow key is held down, the rate at which the digit value changes will be speeded up.

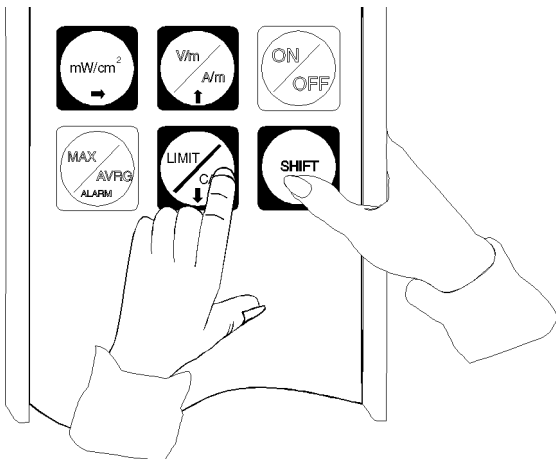

Figure 4-12 Press and hold down the SHIFT key and then use the $\Rightarrow \uparrow$ or \downarrow keys to perform the key functions labelled in blue.

- Press the SHIFT + \Rightarrow keys together. The flashing digit moves to the next digit in the display.
- Use the SHIFT + \uparrow or SHIFT + \downarrow keys to alter the value of this digit. Repeat the above procedure for the remaining digits.

To exit from LIM display and revert to measurement display:

- Press any key except the SHIFT and LIMIT/CAL keys, or

- Wait for a brief interval. The device reverts to measurement display automatically if no entries are made within a ten second period. In this case, the new setting is lost, and the device goes on working with the original value.

Note: If the device reverts to measurement display before you have finished the entry, press LIMIT/CAL again and enter the value again.

Setting the calibration factor (CAL)

To enter the calibration factor, do the following:

- If the display shows LIM: Press the LIMIT/CAL key.
- If the display shows the measured value: Press the LIMIT/CAL key twice.

The display shows the message CAL indicating that entry of the calibration factor is enabled.



Figure 4-13 CAL display. The calibration factor setting is displayed in the lower right corner. The digit which can be altered flashes in the display.

- Change the value of the flashing digit in the calibration factor display by pressing and holding down the SHIFT key and using the \uparrow key to increase the value or the \downarrow key

to decrease the value.

If the arrow key is held down, the rate at which the digit value changes will be speeded up.

- Press the SHIFT + ⇒ keys together. The flashing digit moves to the next digit in the display.
- Use the SHIFT + ↑ or SHIFT + ↓ keys to alter the value of this digit. Repeat the above procedure for the remaining digits.

To exit from CAL display and revert to measurement display:

- Press any key except the SHIFT and LIMIT/CAL keys, or
- Wait for a brief interval. The device reverts to measurement display automatically if no entries are made within a ten second period. In this case, the new setting is lost, and the device goes on working with the original value.

Note: If the device reverts to measurement display before you have finished the entry, press LIMIT/CAL twice to reopen CAL entry and enter the value again.

Setting the averaging time

If you are going to use either AVRG or MAX AVRG mode for measurements, select or check the averaging time setting first. Many standards specify an averaging time of six minutes.

To enter the averaging time, do the following:

- Press the **LIMIT/CAL** key repeatedly until the display shows the message A.TIM indicating that entry of the averaging time is enabled.



Figure 4-14 ATI display

The digital display in the lower right corner shows the set averaging time (minutes : seconds)

- Change the value of the averaging time by pressing and holding down the SHIFT key and using the \uparrow key to increase the value or the \downarrow key to decrease the value.

To exit the ATI display and revert to measurement display:

- Press any key except the SHIFT and LIMIT/CAL keys, or
- Wait for a brief interval. The device reverts to measurement display automatically if no entries are made within a ten second period. In this case, the new setting is lost, and the device goes on working with the original value.

Note: If the device reverts to measurement display before you have finished the entry, press LIMIT/CAL three times to reopen ATI entry and enter the value again.

Switching the alarm function on or off

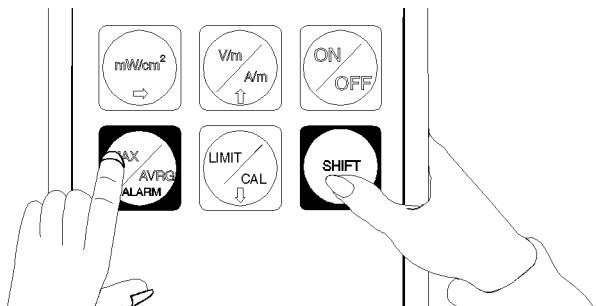

Figure 4-15 Pressing the SHIFT and ALARM keys together switches the alarm function on and off.

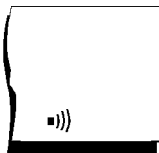

Figure 4-16 This symbol in the display indicates that the alarm function is on

4.4.3 Checking readiness for use

Before making the measurements, make sure that the battery charge is sufficient to cover the anticipated operating time required. Recharge the batteries or replace the dry cells if necessary (see section 3.1 "Power supply").

If you are not sure whether the device is ready for use or not, hold it near to a low grade source of radiation such as a computer monitor. Note how the measured value varies as you change the distance from the monitor. Lower field strength values should be displayed as the distance increases.

4.5 Making measurements

Important: The following effect will be noted with all field strength meters (and particularly those which use a separate probe):

If you move the probe *quickly*, excessive field strength values will be displayed which do not reflect the actual field conditions. This effect is caused by electrostatic charges. In the EMR, special design features were built into the device to minimize this effect. However, if you move the probe very quickly, field strengths on the order of a few V/m can be displayed.

Recommendation: Hold the device steady during the measurement. Delete the stored maximum values and average values by pressing SHIFT + RESET (see also page 4-25) before using the “Max instantaneous”, “Average” or “Max average” mode.

4.5.1 Short-term measurements

Application

For determining unknown field characteristics or for orientation when entering an area exposed to electromagnetic radiation.

Use either "Instantaneous" or "Max. instantaneous" mode.

Procedure

- Hold the device at arm's length.
- Make several measurements at various locations around your work place or the area of interest, as described above. This is particularly important if the field conditions are unknown.
- Pay special attention to measuring in the vicinity of possible radiation sources. Apart from active sources, those components connected to a source may also act as radiators. For example, the cables used in diathermy equipment may also radiate electromagnetic energy, so that the maximum field strength at the work place occurs in the vicinity of the knees. Note that metallic objects within the field may locally concentrate or amplify the field from a distant source.

4.5.2 Long-term exposure measurements

Location

Place the device at your work place between yourself and the suspected source of radiation. Make measurements at those points where parts of your body are nearest to the source of radiation.

Note: Use the "Average" or "Max average" modes only when the instantaneous measurement values are fluctuating greatly. You might wish to use the fold-out stand on the impact protection or fix the device to a wooden or plastic tripod (see section 3.2 "Impact protection").

Starting the measurement

Important: If the device has already been switched on for a time before making the measurement, a number of values will already have been registered. If these are not to be taken into account, i.e. only those values measured from the time the device was placed at the point of interest are to be used, press **SHIFT + RESET (ON/OFF)**.

4.5.3 Alarm function

Alarm stages

The device recognizes two stages of alarm.

- **Stage 1 alarm:**
If the digital display value reaches 10% of the limit value, a sequence of warning beeps is output. The time between the beeps becomes shorter as the measured value increases. When "Instantaneous" and "Average" modes are set, the rate of beeps decreases or no more beeps are heard as soon as the value drops. In "Max. instantaneous" and "Max. average" modes, the signal continues corresponding to the maximum value.
- **Stage 2 alarm:**
When the measured value exceeds the limit value, a continuous tone is output and the LEDs are lit up constantly. If the measured value in "Instantaneous" or "Average" drops below the limit value again, the audible alarm will indicate a stage 1 alarm. The LEDs will flash to indicate that a stage 2 alarm has occurred. In "Max. instantaneous" and "Max. average" modes, the signal continues corresponding to the maximum value.

Clearing an alarm

Clear the visible indication of a stage 2 alarm (limit value exceeded) by pressing any key except the SHIFT key.

Clear the audible alarm signal in "Max. instantaneous" and "Max. average" modes by pressing **SHIFT + RESET**.

4.6 Automatic zeroing

To compensate for offset effects and temperature variations when it is switched on, the device makes an automatic zero adjustment at regular intervals (every 6 minutes). Any measurement in progress is interrupted briefly. The message “null” appears in the display. You do not have to find a field-free location for the zero adjustment to take place.



Figure 4-17 Display during automatic zeroing

Disabling automatic zeroing

To disable the automatic zeroing function, do the following:

- Press SHIFT + LIMIT/CAL
The display shows AOFF indicating that the automatic zeroing function can now be disabled.
- Press SHIFT + LIMIT/CAL again. A short beep indicates that the automatic zeroing function has been disabled.

The device reverts to measurement display if you press any key (except SHIFT + LIMIT/CAL) or if you do not make any entries for a period of ten seconds. In this case, the automatic zeroing function will remain enabled.

Automatic zeroing is re-activated by switching the device off and then on again.

4.7 Error messages

Error messages interrupt the self test and the measurement mode. If the display is working, an error message will be displayed.

Possible error messages



Figure 4-18 An error was detected during the self-test.

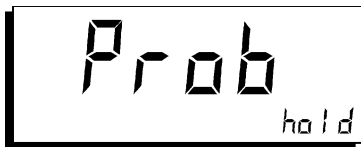

Figure 4-19 A probe was not present during the self-test.



Figure 4-20 No calibration data for the current probe was found.

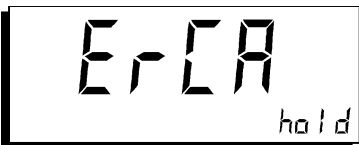

Figure 4-21 The data set stored for the plugged-in probe has a checksum error and cannot be used.

Procedure for correctable errors

1. Correct the error.
2. Press any key (except ON/OFF and SHIFT).

If you cannot correct the error, contact your local Service Center for help.

4.8 Results memory (EMR-30/-300 only)

The EMR-30/-300 also includes a memory function based on a non-volatile store for a maximum of 1500 measured values. The full capacity of the memory allows you to store measurement sequences of between 10 minutes ($dt = 0.4$ s) and 37.5 h ($dt = 90$ s) for “Instantaneous” and “Max Instantaneous” evaluation modes. The memory function can be used to store measured values in two ways:

- Storage of individual values
- Storage of measurement sequences (sequences of measured values)

4.8.1 Storing individual measured values

Store individual measured values as follows (Figure 4-22):

- Briefly press the MEM key. The current memory location number appears in the small display. Each keystroke stores a measured value and increments the memory location number by one. “Stor(e)” appears briefly instead of the measured value to indicate the storage operation.

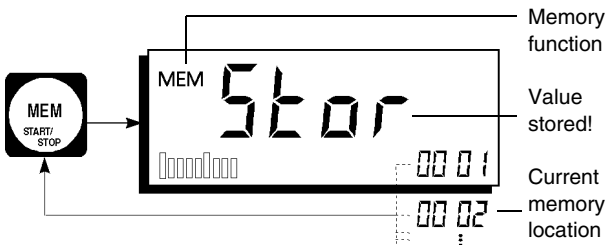

Figure 4-22 Storing individual measured values
(starting with memory location 0001)

Note: In “Max Instantaneous”, “Average” and “Max Average” evaluation modes, the device-internal memories for the MAX, AVRГ and MAX AVRГ values can be reset manually if required by pressing the **SHIFT + RESET** (ON/OFF) keys simultaneously.

4.8.2 Storing measurement sequences

Start and stop storage of measurement sequences as follows (Figure 4-23):

- Press the keys SHIFT + START/STOP (MEM).
Recording of the measurement sequences begins.
Measured values are stored at the preset spacing interval “dt”. The numbers of the memory locations used appear successively in the display.
- Press the SHIFT + START/STOP (MEM) key again.
Recording of the measurement sequence is stopped.

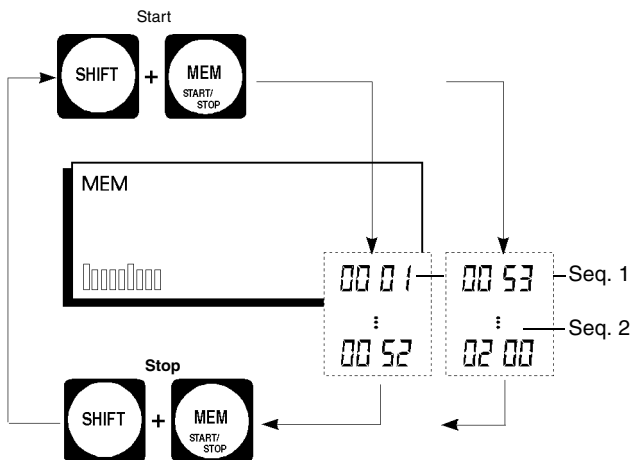

Figure 4-23 Storing measurement sequences, starting with memory location 0001 (sequence 1) and 0053 (sequence 2)

Sequence in “Instantaneous” and “Average” evaluation modes

The displayed values for both evaluation modes are stored at intervals of “dt” in the result memory.

Note: The time interval “dt” can be set between 0.4 seconds and 90 seconds, see page 4-52.

Sequence in “Max” and “Max Average” evaluation modes

To ensure that the sequentially stored set of measured values is meaningful, the corresponding values are reset in a controlled manner: The device-internal values for MAX and MAX AVRГ are deleted at the start of sequential storage and the measurement calculation begins. When the time interval “dt” has elapsed, the calculated value is stored in the result memory and the process begins again with deletion of the MAX and MAX AVRГ values.

Note: The time interval “dt” is directly related to the selected averaging time ATI, see page 4-51.

4.8.3 Deleting measured values

Once the memory is full, you need to clear some locations before you can continue recording. You can delete memory locations individually, or you can clear the entire contents of the memory.

Delete individual memory locations as follows:

- Briefly press the SHIFT + CLEAR (SPATIAL) keys. The most recently stored value is deleted. Its memory location is shown in the small display (Figure 4-24).

Clear the entire memory as follows:

- Press the SHIFT + CLEAR (SPATIAL) keys for about 2 seconds. The complete memory contents will be deleted. "ALL" appears in the small display to show that the entire memory content was cleared (Figure 4-24).

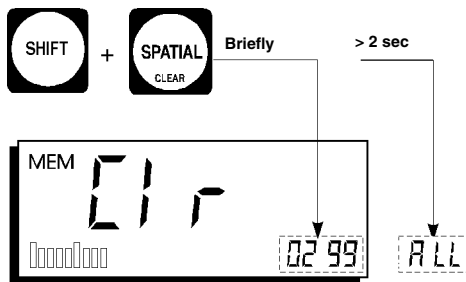

Figure 4-24 Deleting single measured values or all values
Clr (clear) alternates with display of measured values

“Memory full” indication

The memory of the EMR-30/-300 holds a maximum of 1500 measured values. When using the memory, keep track of the memory usage, particularly when recording sequences with a small spacing “dt” or if only a portion of the memory is available for the current storage operation. If you try to store additional values when the memory is full, the “FULL” indication will appear. You must then clear some locations before you can store any more values.



Figure 4-25 Full memory indication

4.8.4 Memory menu

The Memory menu works with the results memory to provide additional functions:

Viewer function

The stored measurement values can be viewed later. All of the occupied memory positions can be accessed.

Time interval “dt”

The time interval “dt” can be set in fixed steps and is used during sequential storage of measurement values.

Baud rate

The baud rate can be selected and is applicable to the “Print results” function.

Calling up functions (Figure 4-26)

- Press the MEM key for about 2 seconds. You should now be in the Viewer function of the Memory menu.
- Briefly press the MEM key. Now, each keypress selects one of the available functions.

Note: To return to the normal display of the measurement result, press any key (except MEM).

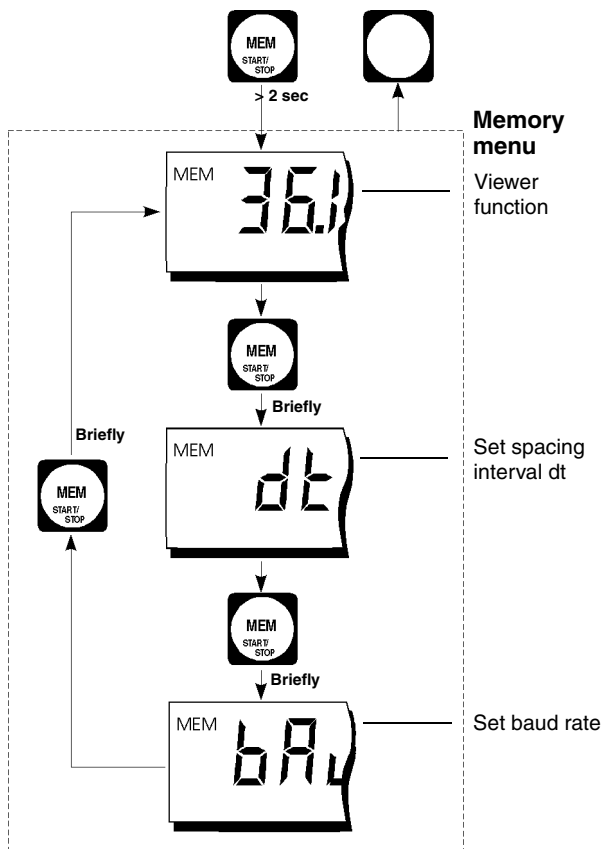

Figure 4-26 The Memory menu

Viewer function

You should be in the Viewer function (Figure 4-26).

Starting with the most recently used memory location (highest number), you can view the contents of other memory locations:

- Press SHIFT+ ↓ (↑). The content of the next lower (higher) memory location is displayed. Continue pressing SHIFT+ ↓ (↑) to view remaining memory locations.

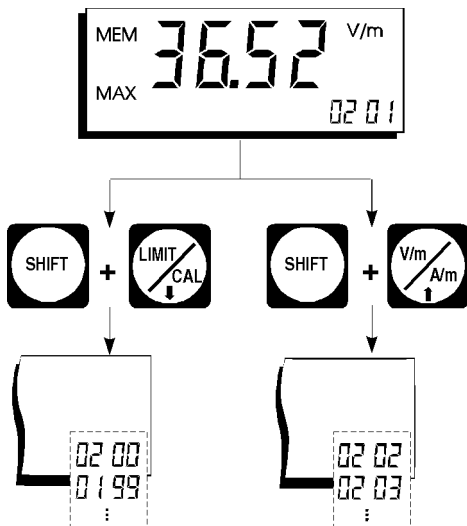

Figure 4-27 Viewing the memory contents (starting with location no. 0201)

Where applicable, the evaluation mode used is shown in addition to the numerical measured value and the units.

Time interval “dt”

The time interval “dt” between each save action for a measurement sequence is set in different ways depending on the evaluation mode:

- “Instantaneous” and “Max Instantaneous”:
The time interval “dt” can be selected in fixed steps as follows: 0.4 / 0.8 / 2 / 4 / 8 / 16 / 30 / 60 / 90 s.
- “Average” and “Max Average”:
The time interval “dt” is directly related to the selected averaging time ATI as shown in the following table:

Averaging time ATI	4 s	8 s	12 s	20 s	32 s	48 s
Time interval dt	4 s	4 s	4 s	4 s	8 s	8 s

Averaging time ATI	1 min	2 min	4 min	6 min	10 min	15 min
Time interval dt	12 s	20 s	40 s	60 s	100 s	152 s

Table 4-7

Setting the spacing interval “dt”

You should be in the “dt” memory item in the Memory menu as shown in Figure 4-26.

- Press SHIFT+ ↓ (↑). The next lower (higher) spacing interval should appear in the small display (Figure 4-28). Continue pressing SHIFT+ ↓ (↑) to activate each available spacing interval in turn.
- Press any key (except MEM) to return to the normal measurement display.

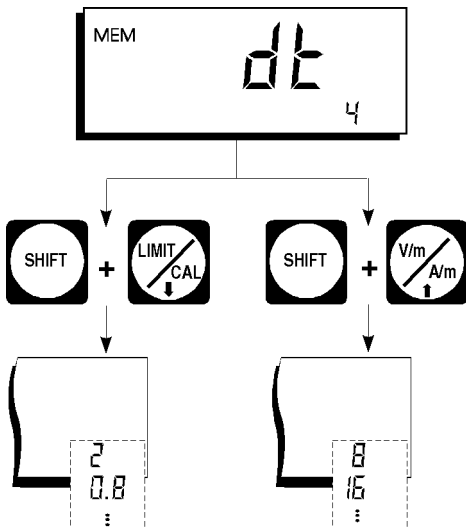

Figure 4-28 Altering the spacing interval (sec)

Note: The values set for the time interval “dt” are retained when the instrument is switched off.

Setting the baud rate

The baud rate for the serial printer can be selected as follows: 1200 / 2400 / 4800 / 9600 baud.

Note: The values set for the baud rate are retained when the instrument is switched off.

You should be in the “bAud” menu item of the Memory menu as shown in Figure 4-26.

- Press SHIFT+ ↓ (↑). The next lower (higher) baud rate should appear in the small display (Figure 4-29). Continue pressing SHIFT+ ↓ (↑) to activate each available baud rate in turn.

- Press any key (except MEM) to return to the normal measurement display.

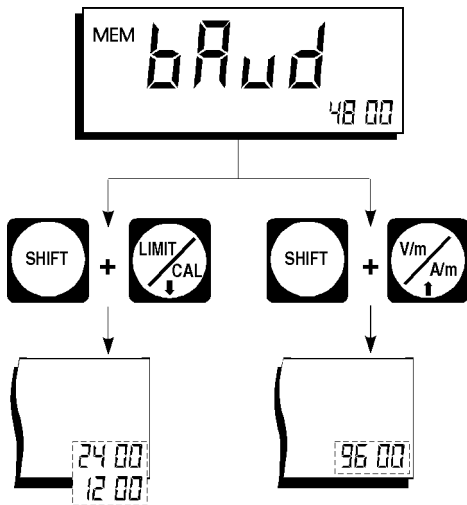

Figure 4-29 Altering the baud rate (starting with 4800 baud)

4.8.5 Printing measured values

You can print out stored measurement results at a later point in time for archival. For each measured value, all relevant device settings such as the unit, mode (averaging), calibration factor and probe are given. In addition, the date

and time of day at which the value was measured is included. The EMR-30/-300 has a built-in real-time clock for this purpose (see also section 4.10).

You can print results in either of two ways:

- Directly using a printer with an RS-232 interface
- Using a terminal or a PC with terminal software

If you wish to print results or control the EMR-30/-300 from a remote site, you will need the PC transfer set available from the accessories line (see section 5).

Printing measured values directly

If you only need to print results, the printer can be controlled directly by the EMR-30/-300 (RS-232 interface). All you need is a connection by way of the PC transfer set.

Settings

Printer: 1 start bit, 8 data bits, 1 stop bit
Baud rate: 1200, 2400, 4800 or 9600 baud

EMR-30/-300: corresponding to baud rate of printer

Output format, control characters

- Measured values: ASCII text
- End of line: CR, LF
- End of print-out: FF

No printer-specific control characters are output so you can use any normal printer.

Starting the print operation

- Press the SHIFT + PRINT (CLOCK) keys.
Printing should begin. The printer status “Prt” appears in the large display, and the memory location numbers appear in the small display. Printing is automatically halted once the last memory location is read out.

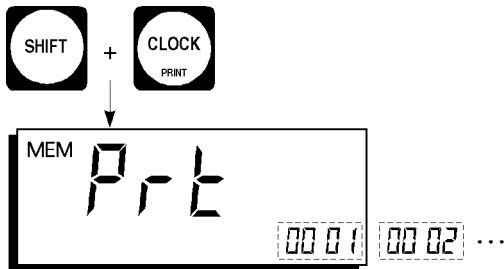

Figure 4-30 Device display while printing

Note: All used memory locations are normally printed out. If you wish to stop printing beforehand, press the **SHIFT+PRINT** keys again.

Loading measured values into the PC

If you set up a connection from the EMR-30/-300 to a PC using the PC transfer set, you can output results directly to a file. Use the EMR-TS program or the “Terminal” program that is normally included in the Microsoft MS Windows 3.1 operating system.

Settings using Terminal

PC:

- Start the terminal software
- Load the configuration file EMR_PCT.TRM (on the diskette with the PC transfer set)
- Set the terminal software to store received measurement data in a file (specify file name)

EMR-30/-300:

- Set baud rate to 4800 baud

Transfer procedure

- Press the **SHIFT + PRINT** keys to initiate the data transfer. You can monitor the data transfer on the screen.
- End the data transfer with the terminal software once the last measured value has been received.

The received measurement data should now be stored in a file. You can edit or print this file like any normal text file.

4.9 Spatial averaging (EMR-30/-300 only)

Using the “Spatial averaging” mode, it is very easy to determine the average field strength in a spatially extended area (area of exposition). While you move with the EMR-30/-300 within a defined zone, the device takes field strength samples. The field strength result is then the root mean square of all recorded samples.

Two recording modes are possible with “Spatial Averaging”. The handling is different in these two modes:

- Formation of an average value through manual recording of measured values at discrete locations (or points in time).
- Formation of an average value through automatic recording of measured values. As you move within the area under investigation, measured values are recorded continuously.



Figure 4-31 “Spatial Averaging” mode for determining the average field strength within a spatially extended area

The average of the previously recorded values always appears in the display. The average values of the “Instantaneous” mode are displayed (“Average” and “Max average” are not taken into account).

Manual sampling

Recording the average field strength in the area of exposition

- Briefly press the SPATIAL key. The EMR-30/-300 is now ready to record values.
- Move about in the area of interest and press the SPATIAL key whenever you wish to record a field strength sample. The average of the field strength is updated each time you press the key. The previous average (digital value) remains frozen between updates. However, the current measured value is still displayed by the bargraph.

Storing the average value

- Press the MEM key. The most recently displayed average value is stored. The number of the memory location currently being used appears in the small display.

Ending SPATIAL mode

- Press the SHIFT + SPATIAL keys. “Spatial averaging” mode is terminated and the device returns to the normal measurement display.

Consecutive sampling

Recording the average field strength in the area of exposition

- Press the SPATIAL key until the device beeps. About one second later, you will hear a second beep. The EMR-30/-300 is now ready to record values. (0.000 appears in the display to indicate that no values were yet recorded).
- Hold down the SPATIAL key and move about in the area of interest. As long as you hold down the SPATIAL key, field strength samples are recorded continuously, averaged and displayed. When the key is released, no samples are recorded. The last valid average value in the display remains frozen. However, the instantaneous field conditions are still displayed on the bargraph.

Storing the average value

- Press the MEM key. The most recently displayed average value is stored. The number of the memory location currently used appears in the small display.

Ending SPATIAL mode

- Press the SHIFT + SPATIAL keys. “Spatial averaging” mode is terminated and the device returns to the normal measurement display.

4.10 Real-time clock (EMR-30/-300 only)

The EMR-30/-300 includes a real-time clock which is used for documenting measured values. Printer logs include the time of day, date and year of recording of each value.

Viewing the clock (Figure 4-32)

- Briefly press the CLOCK key. The time of day should appear in the small display. Press the key again and the date and year and displayed in succession.
- Press any key (except CLOCK) to exit the clock display.

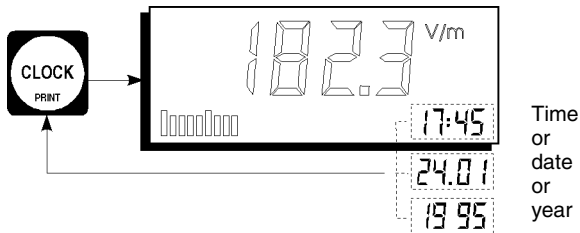

Figure 4-32 Viewing the clock data (press the CLOCK key)

Setting the clock (Figure 4-33)

- Press the CLOCK key for about 2 seconds. You should now be in the CLOCK menu, which is used to set the data for the real-time clock. The time of day is set first; see also the section on page 4-63.
- Briefly press the CLOCK key to set the date or the year. (Each keystroke activates one of these three items for entry.)

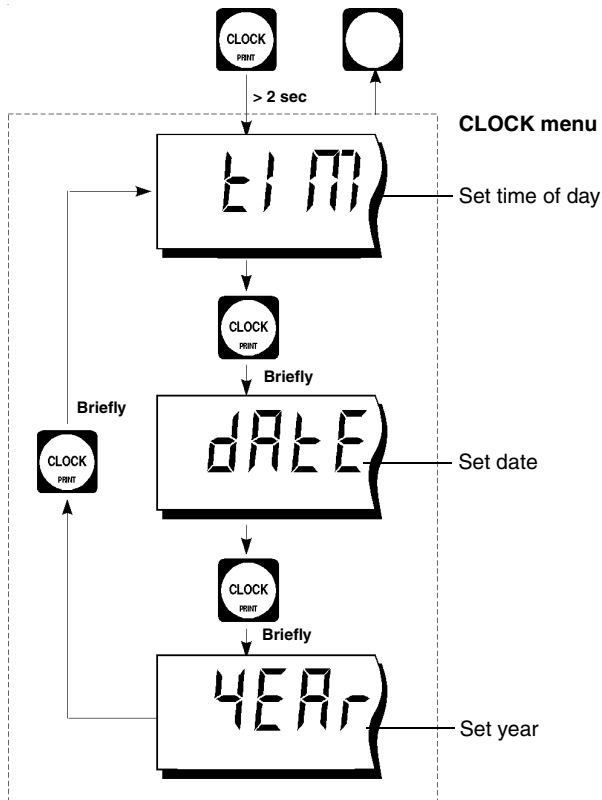

Figure 4-33 The Clock menu for setting the real-time clock

Note: Press any key (except CLOCK) to exit the Clock menu.

Entering the time of day

You should be in the “tiM” item of the Clock menu (refer to Figure 4-33 if not).

- Press the CLOCK key until “tiM” appears in the display. The digit being edited will flash in the small display. You can now enter the time of day.
- Edit the flashing digit in the small display as follows:
Hold down the SHIFT key and:
Press the ↑ key to increase the value
Press the ↓ key to decrease the value.
The digit will change at a faster rate if you hold the arrow key down longer.
- Press the SHIFT + ⇒ keys. The next digit will now begin flashing.
- Edit the next digit with SHIFT + ↑ or SHIFT + ↓ and repeat the process for the remaining digits.



Figure 4-34 Entering the time of day; the digit being edited flashes

Entering the date

You should be in the “dAtE” item of the Clock menu (refer to Figure 4-33 if not).

- Press the CLOCK key until “dAtE” appears in the display. The digit being edited will flash in the small display. You can now enter the date.
- Edit the date with the SHIFT + ↑ (↓, ⇒ keys.

Entering the year

You should be in the “yEAr” item of the Clock menu (refer to Figure 4-33 if not).

- Press the CLOCK key until “yEAr” appears in the display. The digit being edited will flash in the small display. You can now enter the time of day.
- Edit the year with the SHIFT + ↑ (↓, ⇒ keys.

Returning to the measurement display

- Either press any key (except SHIFT and CLOCK)
- Or wait briefly. If you do not press any keys for ten seconds, the device automatically returns to the measurement display. If this happens, the new settings are lost and the device continues using the original values.

5 The optical interface

The LED of the optical interface lights up briefly during the self-test which runs automatically when the instrument is switched on.

This optical interface can be used for remote control of the instrument. This application requires the “PC Transfer Set”, consisting of a fiber optical cable, an opto/electrical converter and a software disk.

The CD contains the EMR-TS software and information for programmers (command sets). EMR-TS uses the LabWindowsTM user interface and is designed to operate with common versions of Microsoft WindowsTM. EMR-TS automatically configures the interface and provides facilities for downloading measurement data and controlling single and continuous measurements.

The program “EMR_CONF” is also included for the EMR-200/-300 devices that allows you to transfer probe data for subsequently ordered probes into the mainframe.

Note:

- For documentation on controlling the EMR via the terminal program, see the file “EMR_REMOTE_REV1.PDF” on the PC Transfer Set CD. This English-language file contains all the relevant information about setting up the link and using the available commands.
- Important for EMR-200/-300: A program for transferring data for new probes into the mainframe is delivered with each probe.

Notes:

6 Care and maintenance

6.1 Saving probe correction data

A type label to be affixed and a diskette containing the probe correction data is supplied with every probe subsequently ordered. This correction data must be transferred to the mainframe before the probe is used.

You need the following items:

- A PC with Windows 3.1 or later
- A PC Transfer Set BN 2244/90.33 or BN 2244/90.34, which is included with the EMR-200/-300.

Transferring the data set to the mainframe

1. Insert the floppy disk (supplied with the probe) that includes the directory EMR/PROBES
2. Install the program using setup.exe
3. Start EMR_CONF
4. Other entries are possible after selecting "Select Com Port"
5. "Probes Data" opens the input window
6. Step 1: First select the correct probe type from the yellow window (top right) so that the data set is stored in the right place for the selected probe
7. Step 2: The version number, serial number and relative sensitivity are quoted on the type label of the probe

8. Stick the probe type label supplied on to the type label on the back of the mainframe instrument (see figure A-4).

Note:

Before writing the probe data to the EMR (write), it is a good idea to first check the contents of the EMR memory by triggering a read operation.

6.2 Cleaning the device

If the device and probe get dirty over time, you can use a towel and a little soap to clean it. Make sure that no moisture gets inside the device, however. Use a dry towel to dry off the device and/or probe after you clean them.

6.3 Lithium battery (EMR-30/-300)

In the EMR-30/-300, power for the non-volatile results memory and real-time clock is provided by a built-in lithium battery. Under normal operation, the battery life is about ten years. However, if you operate or store the device at high temperatures over a long interval of time, the battery life can be significantly diminished.

If stored results are lost or an incorrect time of day is displayed, then this is a sign that the lithium battery is running low.

If this happens, please contact your service center so that they can exchange and dispose of the lithium battery in your EMR-30/-300

Important: Do not attempt to exchange the lithium battery yourself.

6.4 Repair and maintenance information

EMR

No special maintenance is required. Repairs should be performed by authorized professionals only.

Charger Unit

No special maintenance is required. A damaged or faulty device should be exchanged for an intact one.

Notes:

7 Accessories

7.1 Extension cable BN 2244/90.35

When using this extension cable with EMR products, please note the following:

Any cable connection between the sensor and measuring instrument has an effect on the measurement results of a field strength meter. The results may vary according to the orientation of the cable in the field being measured. This is particularly true of high-quality screened cables, as the screening affects the electric field regardless of the impedance of the cables. This is a physical problem that affects all such instruments, not just EMR devices. The effects of using extension cables with field probes cannot be clearly predicted as they depend on several factors, such as field frequency, field polarization, sensor position and position of the cable relative to the field. Narda Safety Test Solutions recommends direct connection of the probe to the mainframe without the extension cable for the most accurate results. This configuration is used for calibrating the instruments and ensures that the specifications are also met.

You may need to use the extension cable if the field to be measured is in a position that is very difficult to reach. In such cases, please note the following:

- The calibration data only apply when the probe is directly connected to the mainframe
- The frequency response and isotropy may deviate from the stated specifications

- The sensitivity may be reduced by up to 20 dBm
- To see the effects of the extension cable, hold the probe steady in the field and move the cable and instrument.

Use of the extension cable is recommended for go / no go tests only. Use of the extension cable should be avoided for making precise, calibrated field evaluations.

7.2 27 MHz Test Generator BN 2244/90.38

The test generator is designed for testing the function of EMR field strength meters. It transmits a continuous signal at 27 MHz. It is not a calibration source.

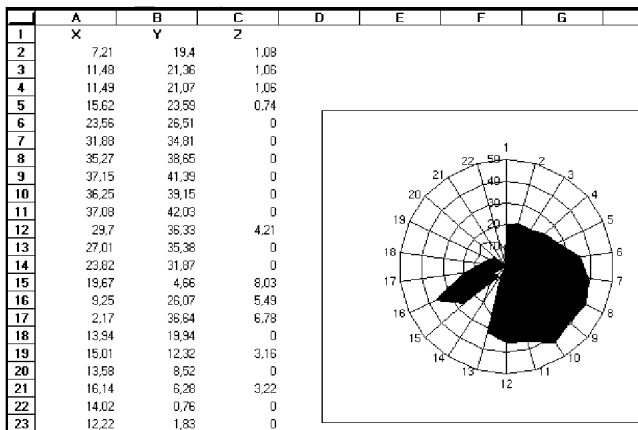

Fig. 7-1 Defective sensor; Z axis has no measured value

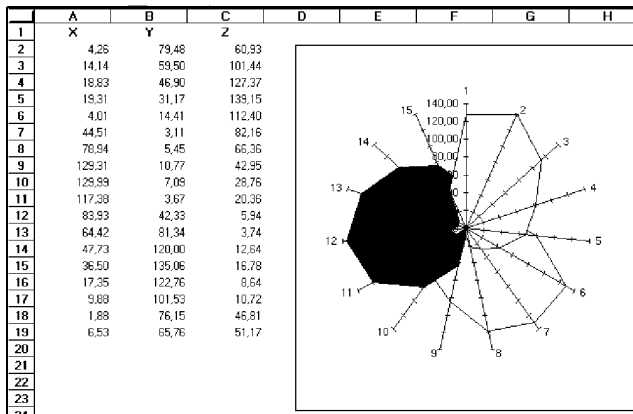

Fig. 7-2 Functional sensor; all three axes show comparable results

To test the function, hold the test generator right on the probe of the EMR you are testing. By mutually twisting the devices, bring the displayed value to a maximum. For reasons related to the design and propagation direction, the spatial axes and the located maximum values will not necessarily agree. In order to determine whether all three sensors are working properly in isotropic probes, connect the EMR to the PC using the transfer set. In “ALL AXIS” mode, you can read off the measured values for all three axes separately and check how they vary for rotation about the probe axis. You can use a spreadsheet such as Excel™ to build a graphical presentation of the results for documentation purposes, as shown here.

Notes:

8 Specifications

8.1 Field strength measurement

8.1.1 General information

Measurement method	digital, triaxial measurement
Directional characteristic.	isotropic, triaxial
Meas. range selection	one continuous range
Display resolution	0.01 V/m 0.0001 A/m 0.01 %
Settling time	typically 1 s (0 to 90% of meas. value)
Display refresh rate	typically 400 ms

8.2 Display and warning indicators

Display type	liquid-crystal (LCD), device specific
Optical alarm	bright red LEDs in foil keypad
Audible alarm	built-in piezoelectric generator, tone sequence depends on measured value

8.3 Measurement functions

Units (flat frequency response probes) V/m, A/m,
mW/cm², W/m², % of LIMIT value

Units (weighted frequency response probes only)
. % of limit value specified in applicable standard

Detection diode rectifier

Displayed value instantaneous measured value,
maximum value
or average value since power-on

Averaging time (in pre-set steps) 4 s to 15 minutes

Alarm function adjustable threshold with ON/OFF

Calibration factor CAL adjustable

8.4 Self-tests

Self-test on power-on: A-D converter, battery, operating voltages, memory and zero alignment.

Regular zero alignment (can be disabled) and battery test during operation.

All tests can be performed while the device is exposed to a field.

8.5 Calibration

Calibration of the instruments is traceable to national / international standards. The scope of calibration and the type of documentation supplied depends on the probe type and the version selected (“Standard” or “Extended Calibration”).

The main difference is in the CAL factors, which are either based on the characteristic frequency response of a given probe type or are the result of individual measurement values obtained from the probe itself.

8.6 Interfaces

Serial interface for transfer of measurement data, remote control and calibration V.24 (RS-232)
optical/bidirectional

8.7 Additional functions EMR-30/EMR-300

Result storage 1500 values
manual or automatic measurement sequence

Spatial averaging over a time period or measurement points.

Real-time clock.

8.8 General specifications

Power supply

Rechargeable batteries 2 x Mignon (AA) 1.2 V

Battery capacity 600 mAh

Dry batteries. 2 x Mignon (AA) 1.5 V

Operating life

Rechargeable batteries typically 8 h

Dry batteries (alkaline manganese) > 15 h

Battery charging. using NT-20 Charger Unit supplied

Ambient temperature

Operating range 0 to +50 °C

Mechanical stress

to IEC 721-3. class 7M3

Dimensions and weight

Dimensions (w x h x d in mm)

including sensor

and impact protection approx. 96 x 64 x 465

Weight (with rechargeable cells) approx. 450 g

8.9 Ordering information

Radiation Meters

EMR-20C¹ Radiation MeterBN 2244/70

EMR-21C² Radiation MeterBN 2244/46

EMR-300 Radiation Meter (mainframe)³BN 2244/31

Field probes

See Appendix B.

Standard accessories (included)

Shock protection with strap and tripod connection

NiCd batteries, Mignon (AA)

NT-20 Charger Unit (please specify type required)

European typeBN 2259/90.01

US typeBN 2259/90.02

UK typeBN 2259/90.03

Australian typeBN 2259/90.04

Japanese typeBN 2259/90.05

-
- 1 E-field probe type 8C BN 2244/90.21 (with extended calibration included)
 - 2 E-field probe type 18C BN 2244/90.73 (with extended calibration included)
 - 3 No field probe included. At least one probe is required for operation. Following accessories included in addition to standard accessories: Desktop Tripod (BN 2244/90.32), PC Transfer Set EMR-TS (BN2244/93.03) and Storage Case (BN 2244/62)

Optional accessories

Transport bagBN 2244/60
Storage Case (aluminium lined)BN 2244/62
Tripod, non-conducting	BN 2244/90.31
Desktop tripod, non-conducting	BN 2244/90.32
PC Transfer Set EMR-TS (O/E converter, optical cable, CD)	BN 2244/93.03
Probe extension cable, 1.2 m flexible	BN 2244/90.35
NiCd/NiMH battery quick charger	
European type.	BN 2259/93.02
UK type.	BN 2259/93.01
Handheld test generator, 27 MHz	BN 2244/90.38

9 Further reading

Standards, regulations and interesting information on the subject of field measurement and evaluation can be found on the Internet at

www.narda-sts.com

Notes:

Appendix A: Instrument overview

A.1 Front panel (example: EMR-300)

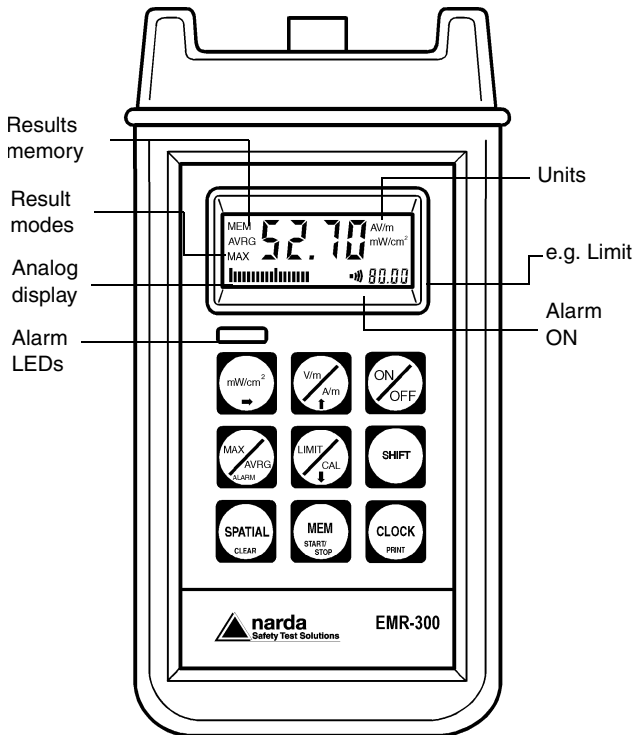

Fig. A-1 EMR front panel with displays and controls

A.2 Side view

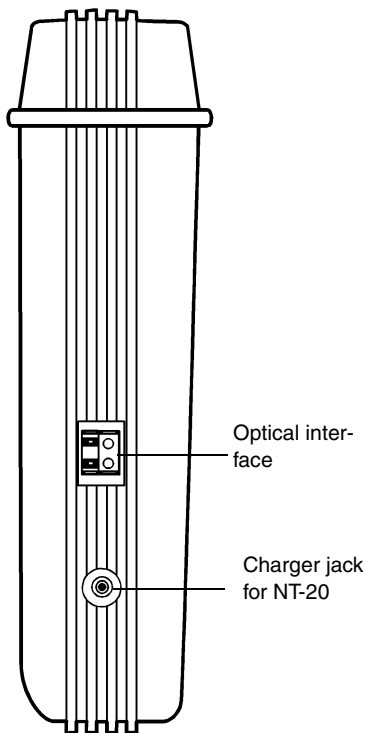

Fig. A-2 EMR side view with charger jack and optical interface

A.3 Rear view

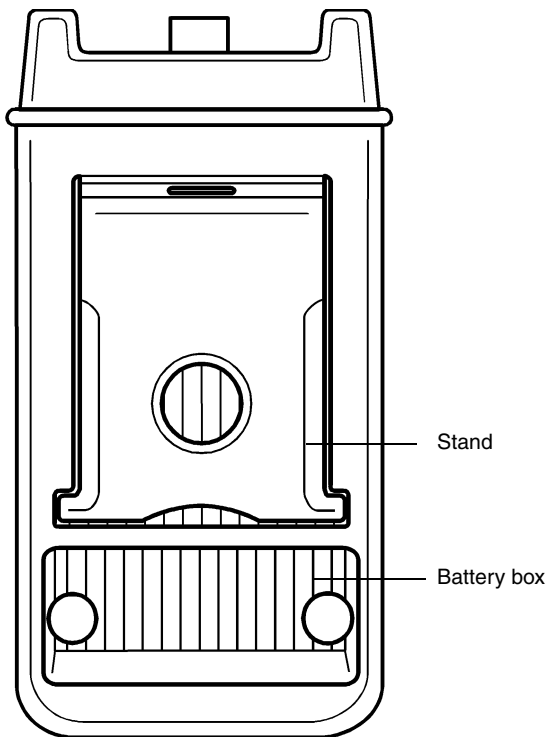

Fig. A-3 EMR rear view with battery box and stand

A.4 Rear view with series labels

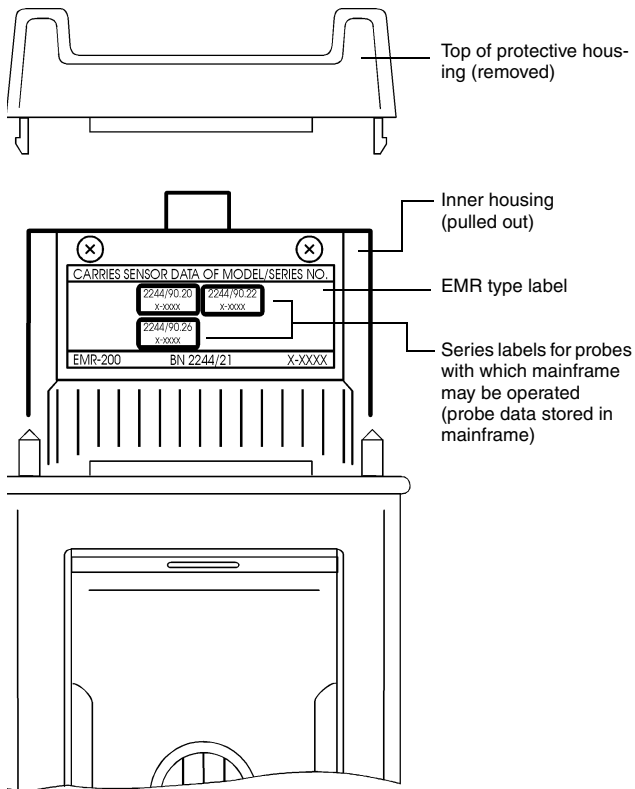

Fig. A-4 Series labels of probes affixed to back panel of EMR-200/-300

Appendix B: Field probes

Ordering information for the field probes are found on the following pages.

For detailed specifications please refer to our Web site:

www.narda-sts.com

Ordering information

Type 8C	E-field probe, 100 kHz to 3 GHz . .	2244/90.21
Type 9C	E-field probe, 3 MHz to 18 GHz . .	2244/90.23
Type 11C	E-field probe, 27 MHz to 60 GHz . .	2244/90.25
Type 10C	H-field probe, 27 MHz to 1 GHz . .	2244/90.27
Type 12C	H-field probe, 300 kHz to 30 MHz .	2244/90.29
Type 13C	H-field probe, 3 kHz to 3 MHz . . .	2244/90.51
Type 14C	H-field probe, 80 MHz to 1 GHz, high sensitivity	2244/90.53

Ordering information

Probes Type 18C to 33C

- **not applicable** for EMR-200/-300 basic units with **serial numbers A, B, C**
- **applicable after upgrade** (see service price list) for EMR-200/-300 basic units with **serial numbers D to O**
- **applicable** for EMR-200/-300 basic units with **serial numbers starting from P (also AA, AB, ...)**

Type 18C	E-field probe, 100 kHz to 3 GHz	2244/90.73
Type 25C	E-field probe, 300 kHz to 40 GHz, shaped according to FCC96-326,OCC	2244/90.59
Type 26C	E-field probe, 300 kHz to 40 GHz, shaped according to ICNIRP, 1998, occ, Canada Safety Code 6/1993/occ, ENV50166-, 1995, occ, BGV B11, 2001, Exp. 1 (occ)	2244/90.61
Type 33C	E-field probe, 300 MHz to 50 GHz, thermocouple sensor	2244/90.81

Notes:

Index

A

A/m 4-1

ALARM 4-32

Alarm function display 4-1

Alarm function on/off 4-3

Alarm stages 4-37

Audible alarm indication 4-2

Average 4-11, 4-36

AVRG 4-1, 4-24

B

BAT 3-4

Batteries, handling 3-1

Battery box 3-9

Battery disposal 3-10

Battery low warning 3-4

Broadcasting facilities 3-12

C

CAL 4-3, 4-28

Calibration 8-3

Charger jack 4-5

Charger unit 2-5

- Charging the batteries 3-5
- Choosing the limit value 4-18
- Choosing the result mode 4-18
- Choosing units of measurement 4-17
- Cleaning 6-2
- Clearing alarms 4-38
- Composite frequencies 4-17, 4-18
- Correct use 2-1

D

- Decreasing the value 4-63
- Default unit 4-20
- Default units 4-9
- Deleting measured values 4-46
- Device does not switch on 3-7
- Diathermy equipment 3-12
- Directional characteristic 8-1
- Dry batteries 3-7

E

- EMR-20/-30/-200/-300 features 1-3
- Erosion machines 3-13
- Err 4-40
- Error 4-40
- Error messages 4-40
- Exchanging the batteries 3-9

Extended calibration 3-14, 3-15

Extension cable 6-2

I

Increasing the value 4-63

Induction ovens 3-13

Instantaneous 4-1, 4-35

Instantaneous mode 4-11

Interfaces 8-3

L

LIM 4-3

LIMIT 4-26

Limit value 4-13, 4-18

Liquid crystal display 4-1

Lithium battery 6-2

Long-term measurements 4-36

M

MAX 4-1, 4-24

Max average 4-36

Max. average mode 4-11

Max. instantaneous mode 4-11, 4-35

Meas. range selection 8-1

Measurement method 8-1

Measurement type 3-12
Measuring range 1-2
Memory menu 4-48
Microwave ovens 3-12
mW/cm² 4-1, 4-23

N

Near-field 4-10, 4-15, 4-18
noCA 4-41
noSE 4-40
null 4-39

O

Observing trends 4-1
Operating life 3-1, 3-7
Operating time counter 3-3
Optical interface 4-5
Options 8-6
Ordering information 8-5
Orientation measurements 4-18

P

PC transfer set 4-56
Power density 4-2, 4-10, 4-17
Power supply 8-4

Printing results 4-54
Probe calibration factors 3-14
Probe connector 4-6
Probe of the same type 3-18
Probe specifications 3-18
Probe types 3-12
Probes that can be connected 1-3
Pulsed signals 4-18

Q

Quick-charging the batteries 3-7

R

Radiation Meter 1-2
Radiation source 4-15
Radiation sources 4-35
Readiness for use 4-33
Real-time clock 4-61
Rechargeable batteries 3-1
Removing the probe 4-7
Replacing the batteries 3-7
Reset 4-12, 4-25
Result modes 4-11, 4-18
RF welding systems 3-13

S

Self-test 4-8

Serial number 3-11

Setting the limit value 4-26

Setting the result mode 4-24

Setting the units of measurement 4-19

SHIFT key 4-4, 4-25, 4-26, 4-28, 4-30, 4-43, 4-63

Six-minute average 1-2

Spatial averaging 4-58

Stage 1 4-37

Stage 2 4-37

Standard accessories 8-5

START/STOP 4-44

Starting the measurement 4-36

Storing measured values

 Measurement sequences 4-44

 Single values 4-43

T

Thermal time-constant 1-2

Trickle charging 3-6

Type label 3-16

U

Units 8-2

Units of measurement 4-10

Unknown fields 4-18

Unknown frequency 4-18

Using rechargeable batteries 3-1

V

V/m 4-1, 4-23

Viewer function 4-48

Visual alarm indication 4-2

W

W/m² 4-1

Notes:

Narda Safety Test Solutions

Sandwiesenstrasse 7
72793 Pfullingen, Germany
Int'l phone: +49 7121-9732-777
Int'l fax: +49 7121-9732-790
E-mail: support@narda-sts.de
www.narda-sts.de

435 Morland Road
Hauppauge, NY 11788
USA
USA phone: 631-231-1700
USA fax: 631-231-1711
E-mail: NardaSTS@L-3COM.com
www.narda-sts.com

